

ESD-TR-68-60
ESTI FILE COPY

ESD-TR-68-60

ESD ACCESSION LIST

ESTI Call No. 84294

ESD RECORD COPY

RETURN TO
SCIENTIFIC & TECHNICAL INFORMATION DIVISION
(ESTI), BUILDING 1211

ESLE

101

Technical Note

1968-18

Lincoln Experimental Satellite-5
(LES-5)
Transponder Performance in Orbit

W. W. Ward
B. E. Nichols

1 November 1968

Prepared under Electronic Systems Division Contract AF 19(628)-5167 by

Lincoln Laboratory

MASSACHUSETTS INSTITUTE OF TECHNOLOGY

Lexington, Massachusetts



BEST AVAILABLE COPY

ADD 686 421

The work reported in this document was performed at Lincoln Laboratory, a center for research operated by Massachusetts Institute of Technology, with the support of the U.S. Air Force under Contract AF 19(628)-5167.

This report may be reproduced to satisfy needs of U.S. Government agencies.

This document has been approved for public release and sale; its distribution is unlimited.

MASSACHUSETTS INSTITUTE OF TECHNOLOGY
LINCOLN LABORATORY

LINCOLN EXPERIMENTAL SATELLITE-5 (LES-5)
TRANSPONDER PERFORMANCE IN ORBIT

W. W. WARD

B. E. NICHOLS

Group 67

Group 62

TECHNICAL NOTE 1968-18

1 NOVEMBER 1968

This document has been approved for public release and sale;
its distribution is unlimited.

LEXINGTON

MASSACHUSETTS

ABSTRACT

A review and analysis of the first in-orbit year of transponder operation aboard the fifth experimental satellite built by Lincoln Laboratory and launched 1 July 1967. The measured performance of the satellite's UHF transponder as a communications repeater is discussed as are its beacon and telemetry systems.

Accepted for the Air Force
Franklin C. Hudson
Chief, Lincoln Laboratory Office

CONTENTS

Abstract	iii
I. INTRODUCTION	1
II. BRIEF DESCRIPTION OF LES-5	3
III. LAUNCH EVENTS AND ORBITAL OBSERVATIONS	4
A. Summary of Operations	4
B. Orbital Elements	7
IV. TRANSPONDER PERFORMANCE	8
A. Effective-Isotropic-Radiated-Power (EIRP) Calculations	8
B. Antenna System and Triplexer	13
C. Noise Figure of the Transponder Receiver	18
D. Local Oscillators and Frequency Translation	19
E. Linear Portion of the Transponder Receiver	24
F. Time Delay Through the Transponder	25
G. Hard-Limiting Characteristics of the IF Unit and RF Transponder Transmitter	27
H. Transponder Transmitter	33
V. BEACON SYSTEM	34
VI. TELEMETRY SYSTEM	39
A. Frequency Stability	39
B. Intermodulation Products Formed between Outputs of the Telemetry and Transponder Transmitters	39
VII. ECLIPSE EFFECTS	42
A. Spacecraft Power System	43
B. Transponder Performance	43
VIII. OBSERVED PROPAGATION EFFECTS	44
APPENDIX A - Measurement of Certain LES-5 Oscillator Frequencies	49
APPENDIX B - Circuit Failure in RF Amplifier 1	52
APPENDIX C - Command Usage	55
APPENDIX D - Power System Degradation	56
APPENDIX E - Reactivation of LES-5 Telemetry Transmitter	59
APPENDIX F - Glossary of Acronyms and Abbreviations	60
Acknowledgments	61
References	62

LINCOLN EXPERIMENTAL SATELLITE-5 (LES-5)
TRANSPONDER PERFORMANCE IN ORBIT

I. INTRODUCTION

The fifth Lincoln Experimental Satellite, LES-5, was launched from the Eastern Test Range in Florida on 1 July 1967 in a multiple-payload Air Force Titan III C vehicle and placed in a near-synchronous, near circular, near-equatorial orbit. This report is concerned primarily with the measured performance of the satellite transponder as a communications repeater. Included are a brief description of the satellite and its orbit, a comprehensive analysis of the performance of the transponder, beacon, and telemetry systems, a brief discussion of performance during eclipse periods, and comments on some observed propagation effects. Other Lincoln Laboratory (LL) reports will cover in detail other areas of the satellite performance including the antenna system and the radio-frequency-interference (RFI) experiment (conducted in collaboration with the Aerospace Corporation).⁸

The major feature of the LES-5 program is the test, demonstration, and evaluation of tactical communications via satellite and the assessment of the technical and operational feasibility of such a system. In addition to Lincoln Laboratory operations, tests and evaluations were performed by agencies of the Air Force, Army, and Navy.

The Laboratory is designing and building prototype models of a modulation system called the Tactical Transmission Systems (TATS) for use with LES-5-class satellites. This system uses coding and frequency-hopping to protect against interference and multipath as well as to serve a large number of users simultaneously with a single satellite. The system provides two rates (75 and 2400 bps) for teletype, vocoder and data. The first of three prototype units was tested successfully on launch day. Two more units have been completed and tested in aircraft and ground vehicles. This design will be the principal modem (modulator/demodulator) to be used in the forthcoming military Tactical Satellite Communications Program. LES-5 and TATS are the initial test models.

The primary ground station for Lincoln's tests and measurements with LES-5 is located on the Laboratory roof in Lexington, Mass. The station uses a 30-ft antenna with tracking feed, a 1-kw transmitter and low-noise receivers. Automatic angle-tracking capability is available for the beacon or a repeated signal. Signal levels are indicated on an Automatic-Gain-Control (AGC) voltage strip-chart recorder and a spectrum-analyzer display. Telemetry data are extracted from the modulation on the beacon signal and recorded on magnetic tape. A quick-look readout on paper tape is also available. A range-measuring system transmits a coded signal through the satellite, receives the signal, and measures the signal's time delay, from which the range

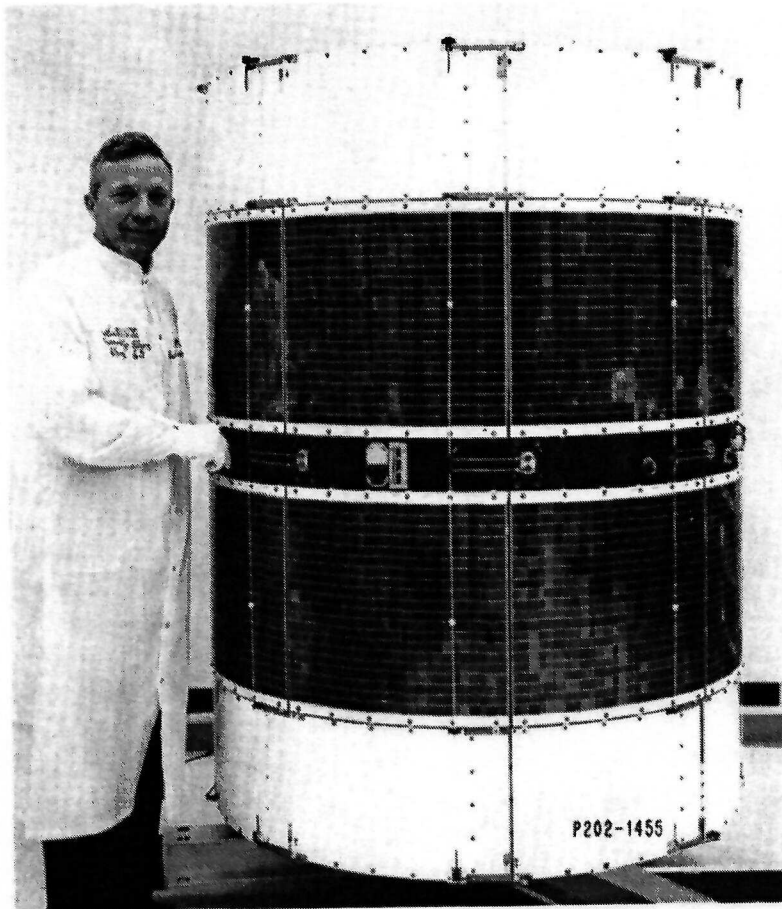

Fig. 1. LES-5 flight spacecraft.

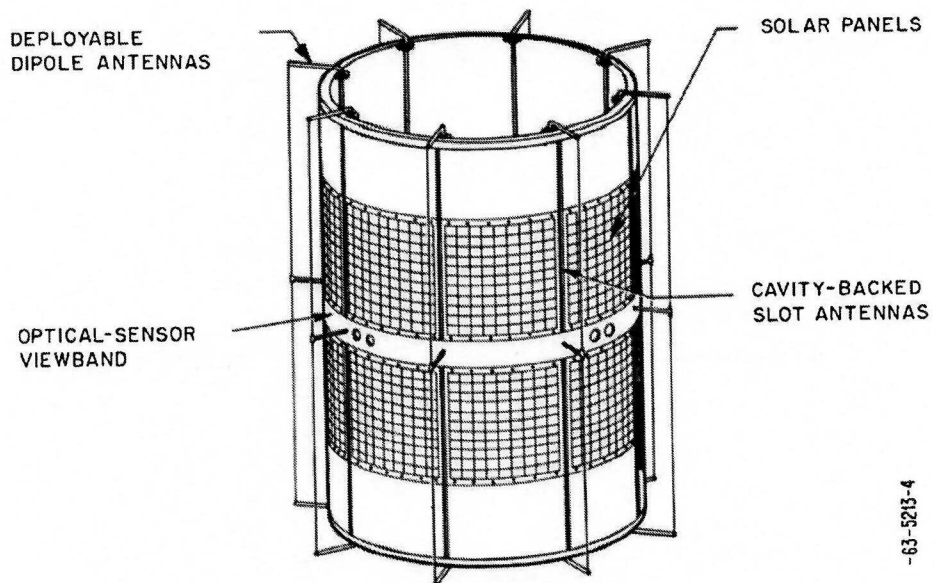

Fig. 2. LES-5 configuration.

can be computed. Range and antenna azimuth and elevation angles are recorded for orbit determination. Command of the satellite's various modes is achieved by transmitting coded and authenticating signals. The RFI instrument is also calibrated from this terminal.

II. BRIEF DESCRIPTION OF LES-5

LES-5 (Fig. 1) is the fifth in a series of active LL experimental satellites launched as part of the Air Force-sponsored LL program in space communications. Its overall mechanical characteristics (Fig. 2) are:

Height	66 in.
Diameter	49 in. (dipole antennas stowed)
Weight	207.5 lb (exclusive of dispenser)
Spin rate	10 rpm (approximately).

Figure 3 shows the toroidal antenna pattern and its relation to Earth. The systematic organization of the transponder (Fig. 4) and communications-associated equipments is conventional. Up-link signals in a band centered on 255.4 MHz are received by the antenna system and separated by the triplexer from the down-link and telemetry signals that may be in simultaneous transmission. After amplification and filtering, the up-link signals are mixed down from RF to IF (32.6 MHz center frequency) where two crystal bandpass filters with nominal bandwidths of 100 and 300 kHz are selectable by ground-station command. After linear amplification and bandwidth selection at IF, the received signals enter an IF variable-gain amplifier and hard limiter. The limited and filtered IF signals are mixed to RF at the down-link frequency (centered on 228.2 MHz) and are combined linearly with a narrowband beacon signal at 228.43 MHz. The total signal passes through a highly efficient RF power-amplifier (PA) chain and out the antenna system via the triplexer. Table 1 is a summary of the pre- and post-launch electrical characteristics of the transponder and beacon.

The primary telemetry system for LES-5 uses a separate transmitter at 236.75 MHz, also via the triplexer and antenna system. In addition, the same narrowband telemetry information is available as part of the beacon-signal format.

The RFI instrument is programmed to scan the RF spectrum from 255 to 280 MHz, transmitting the results of such surveys via the LES-5 telemetry system. The RFI instrument also

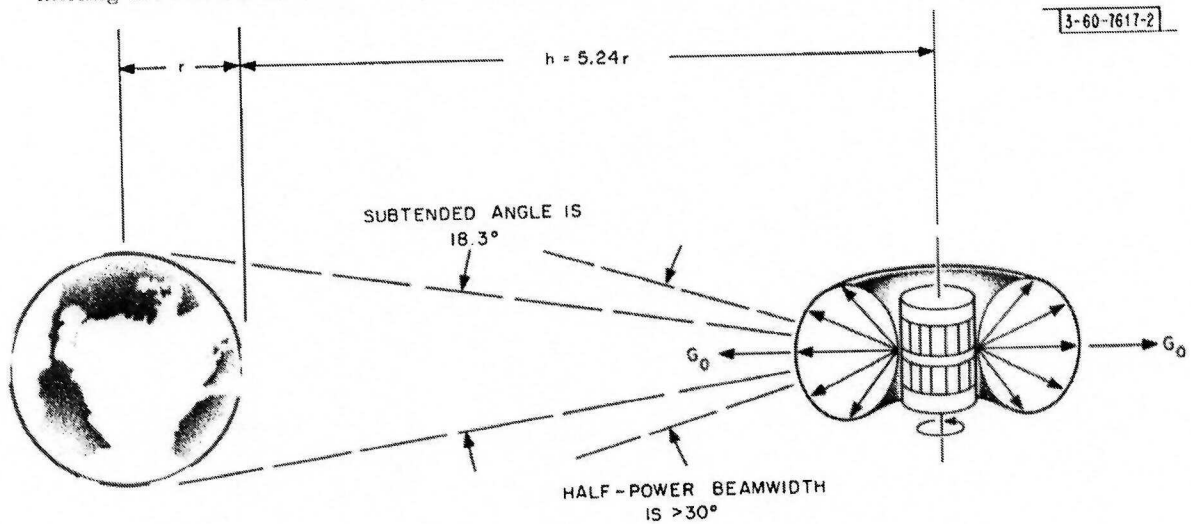

Fig. 3. Illumination of the earth by the LES-5 antenna pattern.

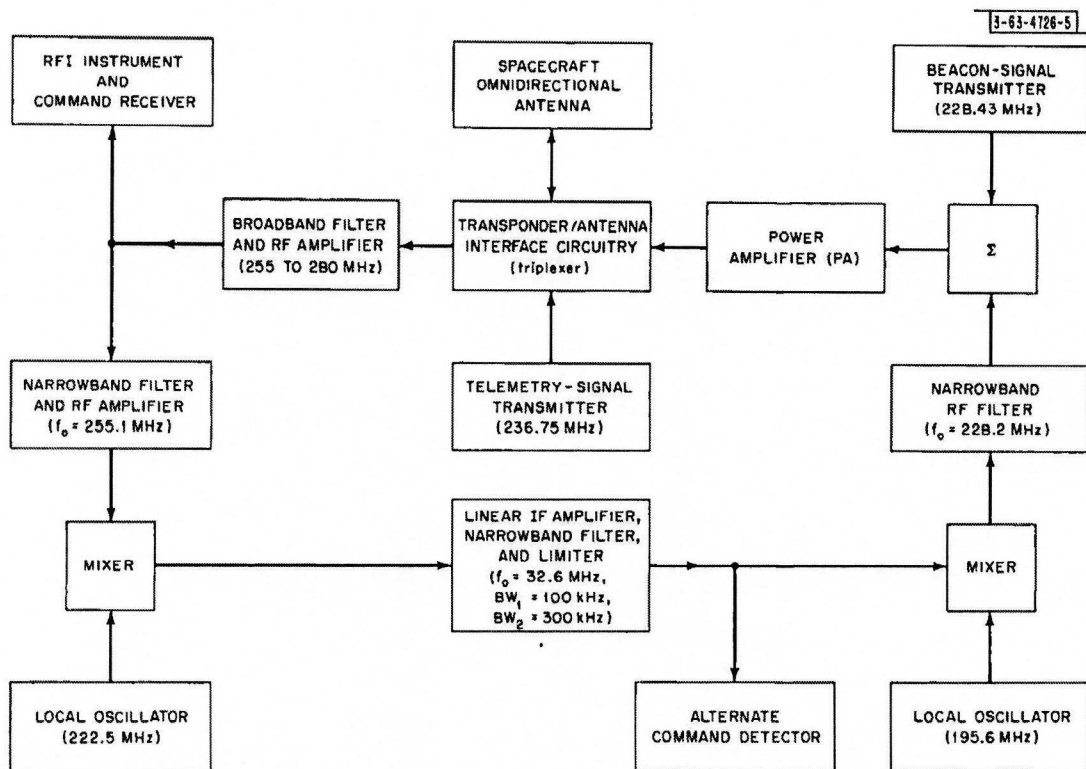

Fig. 4. LES-5 transponder and communications-associated equipments.

serves as the receiver for the primary command channels. For back-up protection, an alternate command channel is provided through the transponder receiver.

III. LAUNCH EVENTS AND ORBITAL OBSERVATIONS

A. Summary of Operations

Following the 1 July 1967 launch, Titan IIIC rocket telemetry signals were observed at the Lexington terminal during the flight to final orbital altitude. On injection into orbit, LES-5 telemetry signals were received at the Westford Communications Terminal at Millstone Hill, Westford, Mass., where they were demodulated and the data transmitted to Lexington for recording and printout.

A timing problem on the satellite was detected from the telemetry data; it precluded satellite reception of commands.* This effect cleared temporarily after about seven hours and several commands were received successfully by LES-5 according to the pre-launch plan. To "Transponder ON" the transponder turned ON in the 100-kHz bandwidth mode; and to "Telemetry OFF," telemetry transmissions terminated on the telemetry frequency and telemetry data were obtained from the received beacon signal thereafter.

Received beacon and transponder signal levels, frequencies, transponder bandwidth, and the satellite-receiver sensitivity were measured. From these measurements and the telemetry data, it was determined that the transponder and beacon were operating essentially as predicted based on pre-launch characteristics. The TATS system was tested monostatically from the Lexington terminal, and from the LET-4† vehicle terminal to the fixed Lexington terminal (one way). Performance was as expected.

* See Section VI for discussion of why the satellite was placed in orbit with transponder OFF.

† Lincoln Experimental Terminal-4.

TABLE 1
ELECTRICAL CHARACTERISTICS OF THE LES-5 TRANSPONDER AND BEACON
(summarized from pre- and post-launch data)

<u>DOWN-LINK</u>	<u>TRANSPONDER</u>	<u>BEACON</u>
Center frequency	228.2 MHz	228.43 MHz
Frequency translation or offset		~ -100 Hz
before Jan. 24, 1968	~ -150 Hz	
after Jan. 24, 1968	~ +1700 Hz	
Nominal bandwidth	100 or 300 kHz	(800/sec biphase modulation of CW carrier)
Antenna		
Polarization	RHCP	RHCP
Gain, satellite equator	+2.5 db	+2.5 db
Gain, 7° off-beam	+2.0 db	+2.0 db
3-db beamwidth	37°	37°
Axial ratio, worst case	3 db	3 db
EIRP, satellite equator	~ 45 w	~ 3 1/2 w
7° off-beam	~ 40 w	~ 3 w
<u>UP-LINK</u>	<u>TRANSPONDER</u>	
Center frequency	255.1 MHz	
Receiver sensitivity, (255.120 MHz)		
before Mar. 18, 1968	{ -115 dbmw (300 kHz) -120 dbmw (100 kHz)	
after Mar. 18, 1968	{ -98 dbmw (300 kHz) -103 dbmw (100 kHz)	
Passband ripple (sensitivity variation from that for 255.120 MHz)		
Narrowband (100 kHz)	{ -1.5 db (more sensitive) +1. db (less sensitive)	
Wideband (300 kHz)	{ -2. db (more sensitive) +5. db (less sensitive)	
Antenna		
Polarization	RHCP	
Gain, satellite equator	+2.2 db	
Gain, 7° off-beam	+1.6 db	
3 db beamwidth	32°	
Axial ratio, worst case	4 db	

A summary of the Lexington-terminal operations log for 1-2 July follows:

<u>1 July (GMT)</u>	<u>OPERATION</u>
1441-1942	Rocket telemetry observations.
1923	LES-5 injected into orbit. Telemetry signals (236.75 MHz) observed on spectrum analyzer.
1944	Telemetry data printed out and recorded from signals sent from Westford. Data collected in this manner until about 0300, 2 July. The stepper-timing problem was observed.
1945-0247 (2 July)	Analysis of the stepper-timing problem. Various commands were tried in various ways in an attempt to cope with the problem.
2151	Transmit CW tone and check telemetry points CL 12 and 13 for reception; received as expected according to telemetry data. A satellite-receiver sensitivity measurement was made.
2218-0109 (2 July)	Transmit Command 30 (a test command) twenty-nine times; not accepted.
<u>2 July (GMT)</u>	
0111-0246	Transmit Command 8, "Transponder ON" seventeen times; not accepted.
0122	Recheck CL 12 and 13 with CW; received.
0247	Observe normal telemetry of stepper-timing rate.
0249	Transmit Command 8 "Transponder ON"; accepted and transponder came ON as observed on receiver spectrum analyzer.
0250	Transmit Command 31 "Commands Normal";* accepted.
0256	Antenna auto-tracking on beacon signal; record antenna angle data.
0300	Make satellite-receiver sensitivity measurement. Start collecting telemetry data using beacon receiver.
0319	Transmit Command 1, "Telemetry OFF," accepted. Westford reports the telemetry signals disappeared.
0320	Remake satellite-receiver sensitivity measurement.
0332-0345	Range measurements; record range and antenna angle data.
0345	Transponder measurements.
0400-0500	First TATS tests via the satellite. Transmit and receive at Lexington terminal, 75-bps rate, message composer and teletype. Then teletype from LET-4 via LES-5 to Lexington terminal, one way. All worked extremely well.
0530	Conclude transmission tests; collect telemetry data for the rest of the night.

Operations with LES-5 continued during each visible period from the Lexington terminal have included:

1. Telemetry-data collection.
2. Transponder-performance measurements.
 - a. Receiver sensitivity
 - b. EIRP calculation
 - c. Bandwidth
 - d. Frequency translation and stability.

* "Command Normal", a preset command situation insuring certain commands to be in effect at Satellite turn-on.

3. Beacon measurements.
 - a. EIRP calculation
 - b. Frequency and stability
4. TATS modem tests, both 75 and 2400 bps rates.
5. Command experiments.
6. Orbit-parameter checks.
7. RFI-instrument calibrations.
8. Polarization-axial-ratio measurements.

On 20 October 1967, the transponder bandwidth was switched by ground-station command from the 100-kHz narrowband mode to the 300-kHz wideband mode. As predicted, the satellite-receiver sensitivity decreased by about 5 db and the EIRP was calculated to be the same as before. The RFI instrument was calibrated by transmitting various power levels from the ground station at various frequencies in the 255 - 280 MHz band. The TATS modem with solid-state message composer was demonstrated many times over LES-5 using the Lexington terminal and LET-4 at the 75 and 2400 bps rates, including full-duplex operation. Extensive testing was carried out during the eclipse season (14 September to 7 November). The satellite performed after emerging from the earth's shadow as it did before entering the shadow.

On 24 January 1968 the nominal down-link signal frequency from the transponder had decreased about 1800 Hz since last 22 December 1967. In addition, the up-link signal frequency had gone up 1800 Hz in order to make a receiver sensitivity measurement with the aid of the crystal-tuned IF, test point X5. This perturbation in frequency translation was pinpointed as a change in the receiver's local oscillator ω . Validity of the frequency measurement was confirmed at the Lexington terminal in several ways by observing, for example, that the beacon carrier frequency did not show any marked change. This effect is discussed in Section IV-D.

On Tuesday, 19 March 1968 during the spring eclipses, receiver sensitivity measurements indicated about a 17-db degradation in noise performance from that measured previously. Ground received signal levels and frequencies were similar to those of the previous visibility. To improve the satellite up-link performance for the small terminal user, especially aircraft, the satellite was commanded from the 300-kHz wideband mode to the 100-kHz narrowband mode that night (20 March 1968). This degradation is discussed in Appendix B.

On 27-29 March 1968, successful operation of a Tactical Transmission System (TATS) modem on an Air Force Systems Command (AFSC) C-135 aircraft was achieved. Good teletype communications were established to the Lexington terminal from the aircraft flying over the western Pacific Ocean. In addition, the aircraft receiver copied its own transmissions, simulating an aircraft-to-aircraft link.

On 23 April 1968, LES-5 was commanded to the 300-kHz wideband mode. The spring eclipse season ended 5 May 1968 with no further significant changes noted. LES-5 was commanded to the 100-kHz narrowband mode on 15 May 1968.

Some scintillation of LES-5 signals, probably caused by ionospheric effects, have been observed for short periods at elevation angles greater than 5° . Variations up to and greater than 10 db have been observed for periods up to about an hour. This fading phenomena is discussed in Section VIII.

B. Orbital Elements

Range, azimuth and elevation-angle measurements at the Lexington terminal were used as inputs to the Laboratory's non-real-time precision orbit determination (NRTPOD) computer

program for determination of the satellite's orbit. Three orbit-fit (computer) routines have been run since launch; the first based on two days of data just after the July launch, a second based on a 13-day span of data including the first data, and a third based on an 11-day span in mid-December.

The most significant cumulative error in long-term prediction based on the July fits arose from a slight error in the initial estimate of the Mean Motion (n). Thus, the main objective of the third fit was to obtain a better value of this quantity and its inverse, the Anomalistic Period.

For a near-circular orbit, only the sum ($M + \omega$) of the Mean Anomaly (M) and the Argument of Perigee (ω) can be determined reliably, hence, neither of them alone can be compared with previously obtained values. A similar disclaimer (although to a smaller degree) can be made about the determination of the Right Ascension of the Ascending Node (Dragon) for a near-equatorial orbit. In this situation, the quantity most reliably determined by an orbit fit is the actual satellite position in Right Ascension (RA), so it was this quantity obtained from the third fit that was compared with the predicted value from the second fit. A 0.44 degree increase in RA on 13 December, given by the third fit, indicated the new improved value of n to be 1.09414658 rev/day, an incremental increase of 0.00000745 rev/day². The elements are:

Epoch	7.0 March 1968
Mean anomaly	0.3681634 + 1.09414658 T*rev
Mean motion	1.09414658 rev MA/day = 33.89277 excess MA deg/day
Anomalistic period	0.913954325 day/rev MA = 1316.09423 min/rev MA
Semi-major axis	6.237088 ER = 39781.17 km
Eccentricity	0.00495892
Inclination	6.495 - 0.00226 T deg
Dragon	296.264 - 0.0122 T deg
Omega (perigee)	295.424 + 0.0371 T deg
Longitude drift	32.93202 deg long/day
Longitude mean motion	0.09147784 rev long/day
Longitude period	10.9316096 day/rev long
Perigee height	5.206159 ER = 33205.74 km
Apogee height	5.268017 ER = 33600.28 km
Lexington-terminal visibility	visible approx. 4 days 21.1 hours not visible approx. 6 days 1.3 hours

As expected, the inclination of the orbital plane is changing slowly with time. This is caused by gravitational effects of the sun and moon, plus the slight oblateness of the earth. Predictions were based on the theory of Allan and Cook.¹ Figure 5 shows the predicted and calculated values from orbit-fits made by the Air Force and Lincoln Laboratory.

IV. TRANSPONDER PERFORMANCE

The in-orbit performance of the LES-5 transponder is discussed block-by-block per Fig. 4. Some sections include over-all performance characteristics. Where in-orbit test data are not available, estimated values from pre-launch tests are supplied.

A. Effective-Isotropic-Radiated-Power (EIRP) Calculations

1. Discussion

Power radiated from an orbiting satellite cannot be measured directly. Instead, the received signal level is multiplied by the ground-station antenna gain, the calculated path loss to

*T = Time in days from epoch.

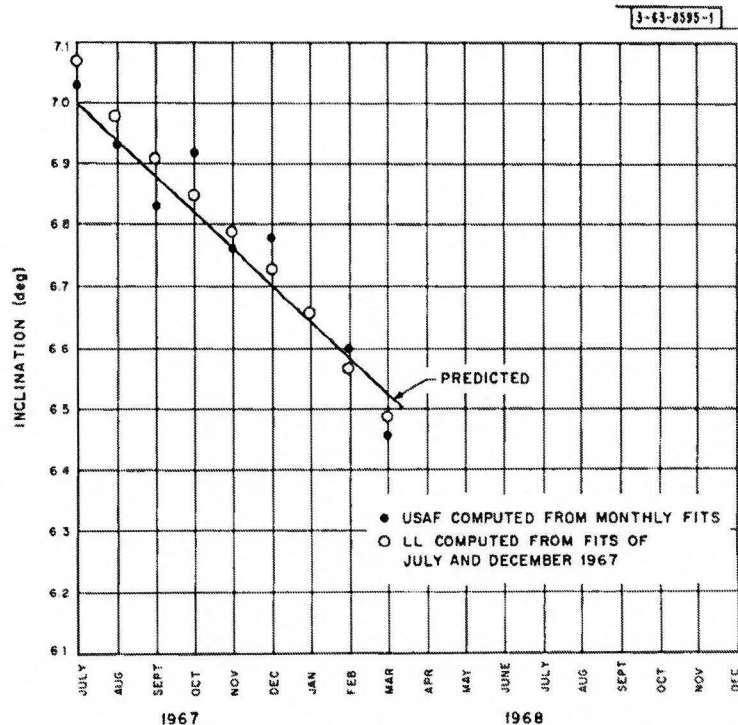

Fig. 5. Inclination variation.

the satellite and other losses. The accuracy of the final calculated EIRP value depends on the accuracy of the number assigned for the ground-antenna gain, matching of the arriving signal polarization to that of the ground antenna, validity of the path-loss calculation, other losses, and accuracy of the calibration signal for the ground-station receiver.

The gain of the Lexington antenna system at the down-link frequency is about 23 db over a lossless Right-Hand Circular Polarized (RHCP) isotrope, based on comparison measurements with a calibrated dipole antenna. The antenna was pointed horizontally to a test source a few hundred feet away and the received signal level was compared to that from the dipole. This was not a good test range for antenna calibration, but it provided the only measurement possible.

The axial ratio of the circular polarization of the antenna system is about 2 db at the down-link frequency. The axial ratio of the polarization of the transmitted signal from the satellite varies from 0 to 3 db as the satellite spins. The polarization-mismatch loss, therefore, would vary from 0 to about $\frac{1}{2}$ db as the arriving signal is in-and-out of alignment with the polarization of the receiving antenna. Up to $\frac{1}{2}$ db of the ripple shown in Fig. 11 could be attributed to this effect.

Path-loss calculations used with these measurements are based on theoretical free-space equations calculated to the nearest tenth db.* No additional loss has been included for atmospheric or other effects.

* Path loss $(4\pi R/\lambda)^2$ varies with distance between the terminal and satellite at the time of data collection. The variation in path loss from LES-5 to a visible point near the surface of the earth does not exceed ± 0.75 db for a standard range of 36,000 km.

Another uncertainty in the EIRP calculation is the precision of the calibrating-signal source for received-signal level. Signal sources, one at the beacon frequency and one at the center of the down-link passband, can be connected to the receiver input via calibrated attenuators, a coaxial cable, and a directional coupler. The power level of the oscillator output is measured. Fixed attenuators are included in series with a 0-100db variable attenuator (in 1-db steps) such that, with the cable loss and coupler, appropriate leak-in levels are available using the variable attenuator. A list of these elements for a typical situation follows:

Source Output		- 32 dbmw
Fixed Attenuators	8 db	
Variable Attenuator	20 db	
Cable Loss	4 db	
Power Splitter	6 db	
Coupler	<u>30 db</u>	
Total Loss	68 db	
Signal Level to Receiver		- 100 dbmw

These elements are subject to error; however, each one has been measured to a tenth db accuracy. Over-all accuracy is estimated to be within $\pm\frac{1}{2}$ db.

Ground-station signal-level measurements are made on single tones using a narrowband receiver. All signals from the satellite must be measured individually and added to determine the total received power. A CW tone is transmitted to the satellite at a level sufficient to fully saturate the hard-limited repeater; this effect is easily observed on the ground-station display. The beacon signal, along with the resulting intermodulation products generated in the satellite, are then measured and included in the total EIRP.

The Lexington station is located at $42\frac{1}{2}^{\circ}$ North Latitude, or about 7° off the satellite's equator (and so off the peak of the satellite antenna beam). This effect must be taken into consideration as the received signal level will be about $\frac{1}{2}$ db less than that received at the earth's equator.

2. Measurements

a. Lexington Terminal

Received-signal levels have been monitored at the Laboratory terminal during each visibility since launch. Beacon levels have varied from about -114 to -116 dbmw, and tones received in the passband center have varied from about -102 to -104 dbmw. These are average values; the ~1-db ripple due to spinning is superimposed on this value. Typical calculations (July 1967) are as follows:

Beacon

Received signal level	- 114 dbmw
(Gain, ground antenna) ⁻¹	- 23 db
Path loss	<u>+172 db</u>
EIRP (RHCP) satellite beacon signal	+35 dbmw, 3.1 w

Transponder

Received signal level	- 103 dbm
(Gain, ground antenna) ⁻¹	- 23 db
Path loss	<u>+172 db</u>
EIRP (RHCP) satellite down-link signal	+46 dbmw, 40 w

Determination of the satellite's total EIRP requires correction for the off-beam measurements at Lexington ($42\frac{1}{2}^\circ$ North latitude) and for the intermodulation products generated. The matching of the incident polarized wave to the antenna polarization is not considered. The following table shows the approximate EIRP at the satellite's equator and at the Lexington latitude.

Approximate LES-5 EIRP, RHCP

	<u>Satellite's Equator</u>	<u>$\pm 7^\circ$ Off-beam (43° Earth Latitude)</u>
Down-Link Signal	43 watts	40 watts
Beacon	$3\frac{1}{2}$ watts	3 watts
Intermodulation Products	$3\frac{1}{2}$ watts	3 watts
Total	50 watts	46 watts

The accuracy of these measurements is estimated to be between +2 and -1 db. Antenna gain and the calibrated-signal level is estimated at ± 1 db. The additional +1 db uncertainty covers the possible polarization-mismatch loss and other unaccounted losses. Therefore, the satellite EIRP could be anywhere between 40 watts (+46 dbmw) and 80 watts (+49 dbmw). The pre-launch measurement of 58 watts (+47.6 dbmw) is well within this range.

b. Antenna Range

In an attempt to obtain a more precise measurement of received-signal level from the satellite, a precisely calibrated rotatable dipole with a gain of 7.1 db at 228 MHz (the same one used with the satellite during pre-launch measurements) was set up at the Laboratory's antenna range. The maximum and minimum signal levels were recorded as the dipole was rotated. A signal generator with a specified accuracy of ± 1 db was used as the calibrating signal. EIRP calculations from these measurements for a single tone toward Lexington on 11 July 1967 were:

	<u>Maximum</u>	<u>Minimum</u>
P_R	-119.5 dbmw	-122.0 dbmw
$(G_A)^{-1}$	-7.1 db	-7.1 db
Path Loss	<u>+170.6 db</u>	<u>+170.6 db</u>
RHCP EIRP	+44.0 dbmw, 25 watts	+41.5 dbmw, 14 watts

These power levels for each linear, orthogonal, polarization add up to 39 watts EIRP, which is consistent with the previously listed calculations.

The $2\frac{1}{2}$ -db variation from maximum to minimum signal implies a received (down-link) circular polarized axial ratio of $2\frac{1}{2}$ db.

This dipole arrangement was not ideal, even with the satellite elevation angle at 41° . Signal-level fluctuations were observed as people walked nearby. Slightly different levels were recorded when the dipole antenna was moved a few feet. Under the circumstances, the values obtained were considered the best achievable.

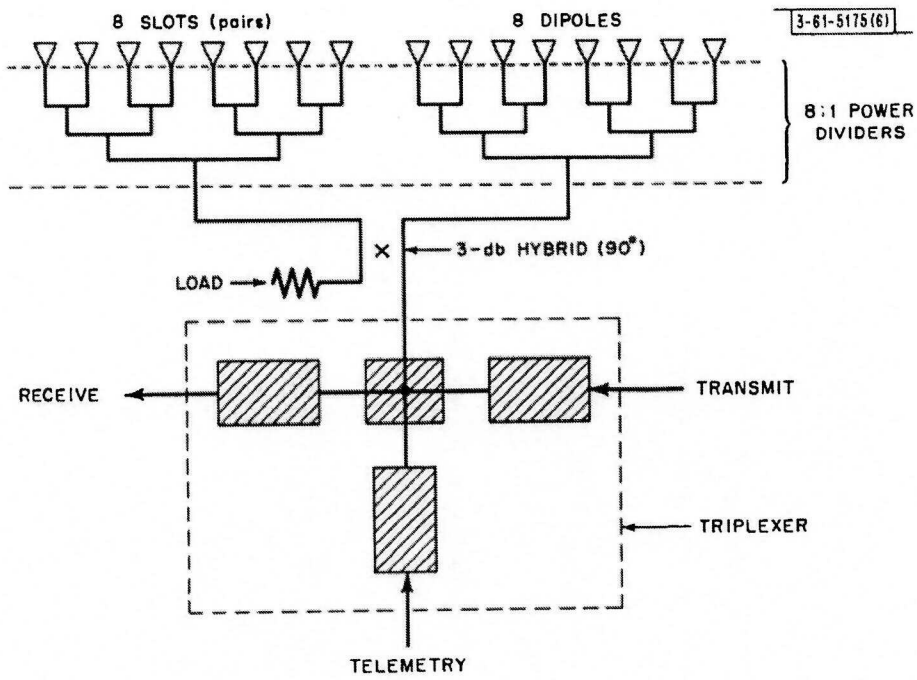

Fig. 6. Antenna feed network.

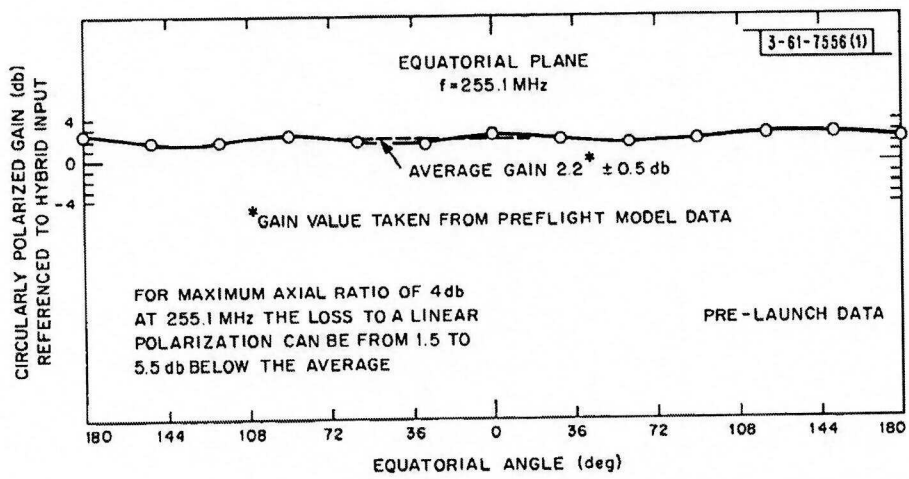

Fig. 7. Circularly polarized equatorial up-link pattern for the flight model.

c. Telemetry Data

Satellite telemetry test point X1 is connected to a crystal detector on a directional coupler in the line from the transponder transmitter to the antenna system. During July 1967, when the measurements cited in sections a and b were made, telemetry data indicated a transmitter power of 45.5 dbmw ($35\frac{1}{2}$ watts) using the appropriate pre-launch counts-to-power calibration curve. The following calculations show the expected RHCP EIRP:

P_T	+45.5 dbmw	
(Triplexer loss) ⁻¹	-0.7 db	
Satellite antenna gain, 228 MHz	+2.5 db	
Total EIRP satellite's equator	+47.3 dbmw,	54 watts
Total EIRP, 7° off-beam	+46.8 dbmw,	48 watts

These quantities are consistent with measurements noted in sections a and b.

Telemetry test point X1 has been monitored during each visibility since launch, and the transmitter power indicated has been within +45.3 to +46.3 dbmw. The higher number is less precise because a counts-to-power calibration curve was not available for the detector's estimated temperature at the time of that observation.*

B. Antenna System and Triplexer

This section describes briefly the characteristics of the LES-5 antenna system based on pre-launch data as they relate to the operation of the transponder, beacon, and telemetry transmitters. Technical details of the antenna system will be reported separately.¹⁰ The triplexer is described in another report.²

1. Antenna System at the Up-Link Frequency

The LES-5 antenna system (Fig. 6) transmits and receives signals with nominal right-hand circular polarization (IEEE definition). The component of the E-field vector parallel to the spacecraft axis is provided by eight center-fed dipoles deployed from their stowed positions after ejection from the launch vehicle. The desired orthogonal component of the E-field vector is provided by eight cavity-backed slot pairs (the members of each pair lie above and below the sensor viewband). The two components of the total E-field are suitably phased to yield the desired sense of circular polarization.

Insufficient time before launch prevented taking a complete set of antenna system data on the flight model over the 255 - 280 MHz band. Partial data taken at 255.1 MHz are in general agreement with similar data taken earlier on the preflight model. Figures 7 and 8 are representative of the LES-5 flight model (see also Table 2).

The gain variation in the equatorial plane of LES-5 with azimuthal rotation is ± 0.5 db. For an elliptically polarized wave having a ratio $\rho \geq 1$ of the major to minor field amplitudes, the

* See Appendix D for recent data.

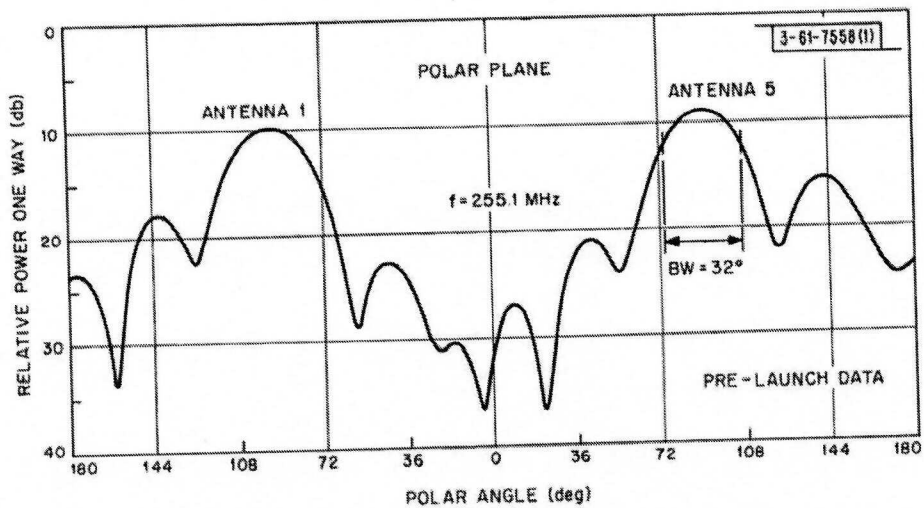

Fig. 8. Circularly polarized polar up-link pattern for the preflight model.

TABLE 2 LES-5 PRE-LAUNCH FLIGHT MODEL DATA			
f(MHz)	228.2 (Transmit)	236.75 (Telemetry)	255.1 (Receiver)
EIRP - to matched polarization with spin variation	Max 64.5 W +0.45 db Avg 58.3 W -0.20 db Min 55.5 W	Max 0.514 W +0.4 db Avg 0.470 W -0.5 db Min 0.426 W	
Polar patterns circularly polarized	0.5 db down at $\pm 7^\circ$ 3-db beamwidth - 37°	0.5 db down at $\pm 7^\circ$ 3-db beamwidth - 35°	0.6 db down at $\pm 7^\circ$ 3-db beamwidths* - 32°
Axial ratio (worst case)	~3 db	~3 db	~4 db
EIRP TO GROUND OR AIRBORNE LINEARLY POLARIZED ANTENNA			
Minimum EIRP observed by linearly polarized antenna†	Transmit		Telemetry
	Max 21.9 W Avg 19.8 W Min 18.8 W		Max 0.175 W Avg 0.159 W Min 0.144 W
*Taken from preflight-model pattern data.			
† 4.8 db down from the circularly polarized EIRP values, calculated for transmission from a 3-db-axial-ratio circularly polarized antenna to a linearly polarized antenna.			

total power in the radiated field in a given direction is proportional to $(1 + \rho^2)^{-1}$. A linearly polarized antenna lying in the far field of the LES-5 antenna system receives a proportionate fraction of this total power, varying between $(1/1 + \rho^2)$ and $(\rho^2/1 + \rho^2)$, depending on the orientation of the polarization ellipse. Both bounds go to $\frac{1}{2}$ (3-db down) as $\rho \rightarrow 1$ (perfect circular polarization).

For system-performance calculations, the maximum axial ratio (ρ^2) is assumed to be 4 db. The polarization-mismatch loss between the LES-5 antenna and a linearly polarized terminal antenna can, therefore, vary between 1.5 and 5.5 db, depending on orientation of the terminal antenna with respect to the polarization ellipse after possible Faraday-effect rotation in passing through the ionosphere. This polarization-mismatch loss is also considered to include the effects of the ± 0.5 -db azimuthal gain variation.

The 3-db-down beamwidth at 255.1 MHz of the LES-5 antenna system in a plane containing the spacecraft axis is about 32° . Assuming proper orbital insertion and attitude stabilization, the loss from peak gain for terminals at high latitudes is small (0.6 db for $\pm 7^\circ$ elevation angle at the satellite, corresponding to $\pm 45^\circ$ latitude on Earth; compare Fig. 3). In this connection, the attitude of LES-5 on injection into orbit was very near the planned value. During July 1967 the spin axis precessed a few degrees from that attitude under the influence of solar torques. The magnetic-stabilization system was commanded ON on 2 August 1967. It swiftly brought the spin axis back to the nominal position. The magnetic-stabilization system holds the spin-axis attitude within a dead band of $\pm 2^\circ$.

Integration of LES-5 antenna patterns at 255.1 MHz shows that directivity of the beam is 4.5 db. The difference between this number and the measured peak gain of 2.2 db is caused by mismatch and dissipative losses in the antenna system itself. The proportion of cross-polarized radiation (left-hand circular polarization) is small at this frequency.

In general, characteristics of the LES-5 antenna system throughout the remainder of the RFI experiment band (255 to 280 MHz) show decreasing gain and increasing axial ratio.

For interest, the effective receiving cross section of the LES-5 antenna system at 255.1 MHz, in the equatorial plane of the spacecraft, is

$$\begin{aligned} A_r &= \frac{G \lambda^2}{4\pi} \\ &= \left(\frac{1.68}{4\pi}\right) \left(\frac{3 \times 10^8}{2.551 \times 10^8}\right)^2 \\ &= 0.18 \text{ m}^2 \rightarrow -7.4 \text{ dbm}^2 \end{aligned}$$

referred to the antenna port of the triplexer (see Fig. 6).

In-orbit confirmation of these antenna characteristics is limited. If antenna-system performance was drastically deficient, it would be reflected in system results. The only tangible evidence adduced about antenna-system performance at the up-link frequency comes from transponder-sensitivity tests using the crystal-tuned test point (Section IV-G). The general stability of

* Performance of the LES-5 antenna system is explained on the assumption that it is radiating. The same relationship holds for reception.

telemetry readings when the up-link signal is well below saturation of the limiting IF circuitry suggests that the spin modulation (equatorial ripple) of the LES-5 antenna pattern at the up-link frequency is small (consistent with Fig. 7).

2. Antenna System at the Down-Link Frequency

Figures 9 and 10 (see also Table 2) present data taken on the LES-5 flight and preflight models at 228.2 MHz (the down-link frequency). Note that the ordinate scale for Fig. 9 is linear in power rather than logarithmic (as for Fig. 7). The nominal down-link polarization is right-hand circular (IEEE definition).

The EIRP variation in the equatorial plane from the average value of 58.3 w is +0.45, -0.20 db. The axial ratio (ρ^2) does not exceed 3 db. The polarization-mismatch loss between LES-5 and a linearly polarized terminal antenna can, therefore, vary between 1.8 and 4.8 db, depending on the orientation of the terminal antenna with respect to the polarization ellipse after possible Faraday-effect rotation in passing through the ionosphere. This polarization-mismatch loss is also considered in system-performance calculations to include the effects of the azimuthal gain variation.

The 3-db-down beamwidth at 228.2 MHz of the LES-5 antenna system in a plane containing the spacecraft axis is about 37°. Assuming proper orbital insertion and attitude stabilization of LES-5, the loss from peak gain for terminals at high altitudes is small (0.5 db for $\pm 7^\circ$ elevation angle at the satellite, corresponding to $\pm 45^\circ$ latitude on Earth; compare Fig. 8). (The magnetic-stabilization system acts to hold the spin-axis attitude within a dead band of $\pm 2^\circ$.)

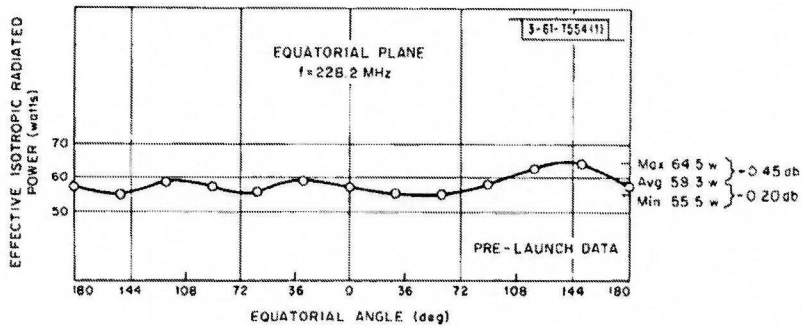

Fig. 9. Circularly polarized equatorial transponder EIRP pattern for flight model.

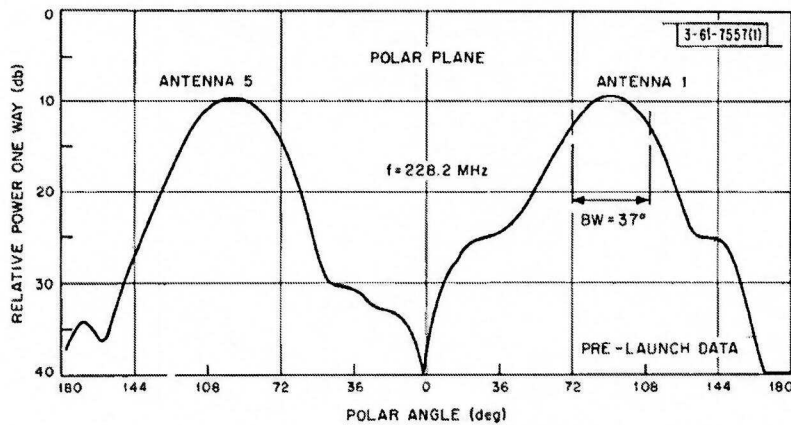

Fig. 10. Circularly polarized polar transponder down-link pattern for preflight model.

Integration of the LES-5 antenna patterns at 228.2 MHz shows that the directivity of the beam is 4.35 db. The difference between this number and the measured peak gain of 2.5 db² is caused by mismatch and dissipative losses in the antenna system itself. The proportion of cross-polarized radiation (left-hand circular polarization) is small at this frequency.

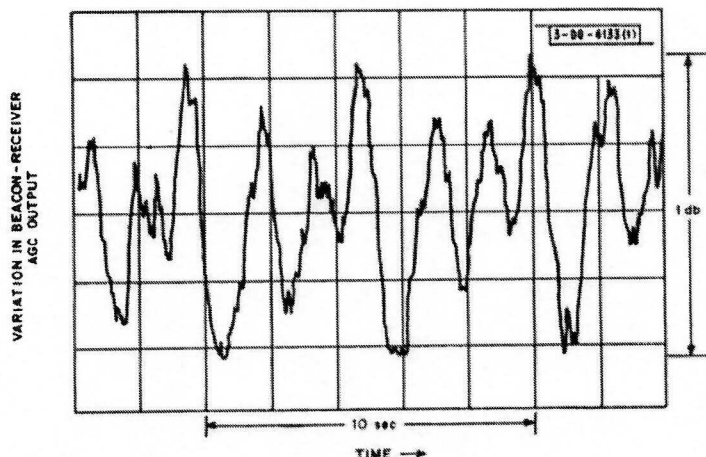

Fig. 11. Spin-modulation effects.

In-orbit confirmation of these antenna characteristics is somewhat indirect. The results of EIRP measurements in orbit (Section IV-A) can be compared with the just cited results of pre-launch measurements. One tangible confirmation is given in Fig. 11. The peak-to-peak ripple in the beacon signal (very near the down-link frequency) is in general agreement with Fig. 9. Note that the spin period can be measured approximately (~5.3 sec) from the waveform on this record. Records made at other times, when the terminal was looking into the LES-5 antenna pattern at a different conical-cut angle, show slightly different waveforms.

3. Antenna System at the Telemetry Frequency

The EIRP of the primary telemetry system as measured on the flight model is shown in Fig. 12. Note that the ordinate scale is linear in power rather than logarithmic (as in Fig. 7). No polar-cut patterns (similar to Figs. 8 and 10) are available at the primary telemetry frequency. Some further data on the radiation characteristics of LES-5 at this frequency are given in Table 2. The nominal polarization is right-hand circular (IEEE definition).

No reliable EIRP measurements were made during initial turn-on of the LES-5 telemetry system. (Appendix E has more recent data.)

4. Summary of Antenna System Characteristics

A summary of some pre-launch measured characteristics of the LES-5 antenna system at the up-link, down-link, and telemetry frequencies is presented in Table 2. The EIRP data at the bottom of the table are MINIMUM numbers based on conservative assumptions: (a) that the maximum axial ratio (3 db) applies for the direction from the satellite to the terminal, and (b) that the linearly polarized terminal antenna is oriented in the unfavorable way (parallel to

* The down-link power into the antenna system was found during pre-launch system testing to be about 32 w. There were also independent measurements of antenna-system gain at 228.2 MHz.

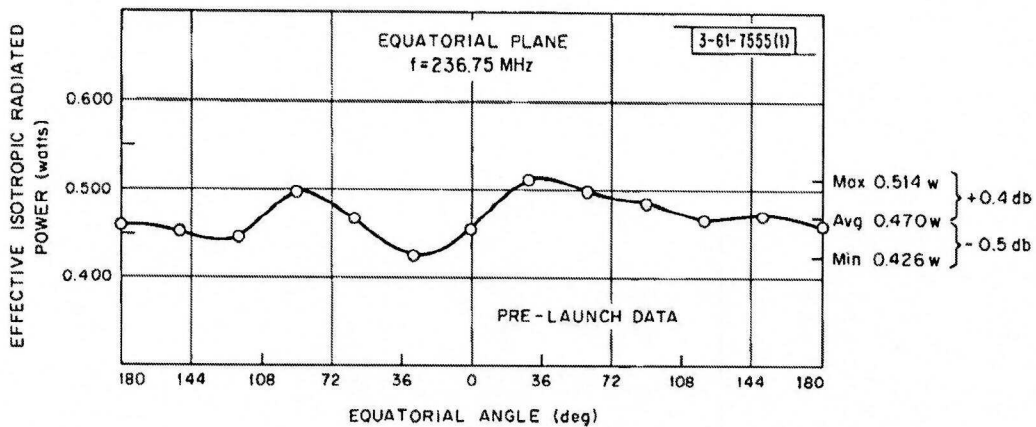

Fig. 12. Circularly polarized equatorial telemetry EIRP pattern for flight model.

the minor axis of the polarization ellipse as received at the terminal). System-performance calculations should include these numbers as well as the corresponding MAXIMUM ones, for which the terminal antenna is oriented in the favorable way (parallel to the major axis). Favorable and unfavorable orientations are equally likely. They must both be considered, for the spread between them will introduce a corresponding amount of scatter in system-performance numbers.

C. Noise Figure of the Transponder Receiver

The noise figure of the transponder receiver is discussed from two standpoints. On one hand, RF amplifier 1 (Fig. 4) is characterized by its bench-measured standard noise figure F_o at the up-link frequency of between +3.0 and +3.2 db (reference temperature T_o is 290°K) over the range of equilibrium temperatures to be expected in orbit. On the other hand, the system noise figure F_{sys} includes the effects of sky noise received by the LES-5 antenna system as well as of noise contributions from lossy components in the antenna itself. For each noise figure F , it is occasionally convenient to use one or another of these equivalent formulations:

Equivalent input noise temperature	$T_{eq} = T_o F$
Equivalent one-sided input noise-power density	$\mathcal{P}_n = kT_{eq} = kT_o F$
Equivalent input noise power in bandwidth B	$P_n = \mathcal{P}_n B = kT_{eq} B = kT_o F B$

The value of Boltzmann's constant k is 1.38×10^{-23} joule/°K.

The equivalent system noise temperature $(T_{eq})_{sys}$ is related to the standard noise figure of RF amplifier 1 by this equation:³

$$(T_{eq})_{sys} = \frac{T_a}{L} + \left(\frac{L-1}{L}\right) T_L + (F_o - 1) T_o$$

T_a (equivalent noise temperature seen by the antenna, referred to its radiating elements) is assumed to be 400°K. L (over-all RF loss of the antenna system, eabling, and triplexer receive arm) is estimated to be +2.6 db (1.8197). The temperature (T_L) of this spacecraft equipment in orbit is taken to be 273°K (0°C). Then

$$(T_{eq})_{sys} = 220 + 123 + 316 \approx 660^\circ\text{K}$$

If $T_a \neq 400^\circ\text{K}$, $(T_{eq})_{sys}$ is affected correspondingly. A much lower value of T_a would make the transponder appear to be more sensitive in orbit than it was during pre-launch tests (Section IV-G).

The various characterizations of the noise figure of the transponder receiver, based on the foregoing data and equations, are collected in Table 3.

Characterization		RF Amplifier 1 Alone (subscript "o")	Complete System (subscript "sys")
Noise figure F		+3.2 db	+3.6 db
Equivalent input noise temperature T_{eq}		606°K	660°K
Equivalent one-sided input noise power density \mathcal{P}_n		-170.8 db: (mw/Hz)	-170.4 db: (mw/Hz)
Equivalent input noise power P_n in bandwidth B	Narrowband (B = 100 kHz)	-120.8 dbmw	-120.4 dbmw
	Wideband (B = 300 kHz)	-116.0 dbmw	-115.6 dbmw

There is no provision in LES-5 to measure the noise figure of the transponder receiver directly. Rather, it has been found preferable in system testing, both before and after launch, to check the sensitivity of a transponder receiver by observing the output signal at some test point past the IF limiter (Section IV-G). Such a measurement also discloses point-by-point variations in sensitivity across the communication band. These variations originate in passband ripples of the crystal IF bandpass filters (Section IV-E). The equivalent input noise power with which an up-link signal must contend is a number like that just calculated. Obtaining a given signal-to-noise (S/N) ratio at the output of linear IF circuitry will require more up-link signal power at a frequency for which the constant-input response of the crystal IF bandpass filter is reduced from its peak value. Sensitivity of the transponder receiver is correspondingly inferior at that frequency.

[This section was written before the circuit failure in the first RF amplifier, associated with the eclipse of LES-5 by the earth on 18 March 1968, discussed in Appendix B. The principal consequence of the failure has been a degradation in the system noise figure (or noise temperature) of approximately 17 db at the up-link frequency.]*

D. Local Oscillators and Frequency Translation

The two local-oscillator (LO) signals (Fig. 4) are obtained by frequency-doubling the outputs of temperature-compensated, crystal-controlled, transistor oscillators. The crystals are AT-cut and operate in the fifth-overtone mode. The design goal for these oscillators was ± 1 ppm variation over a 0 to $+40^\circ\text{C}$ range.

The IF center frequency (32.6 MHz) and the frequency of the second (up-converting) LO (195.6 MHz) have been chosen as $1/7$ and $6/7$, respectively, of the down-link center frequency (228.2 MHz), to minimize problems caused by harmonic frequency components and responses. The frequency of the first (down-converting) LO (222.5 MHz) is determined by the IF and up-link

* Note added during proofreading: The transponder suddenly regained its original sensitivity on 14 November 1968.

(255.1 MHz) center frequencies. Each LO frequency lies below its associated (input or output) RF frequency. The transponder, therefore, preserves (i.e., does not invert) the spectra of signals passed through it.

1. Output Power

For some time before launch it was known that the temperature sensitivity of LO 1 was abnormally large compared to the test-point-measured power output of LO 2. Some instabilities within the LO's were eliminated at Cape Kennedy by rebuilding their output sections. There remained a turn-on effect, lasting several minutes, in which the telemetered output of LO 1 came to its steady-state value from an initial, slightly higher, value. This effect has been observed in orbit during turn-on after eclipse. It was established at Cape Kennedy that this effect was not in the telemetry system.

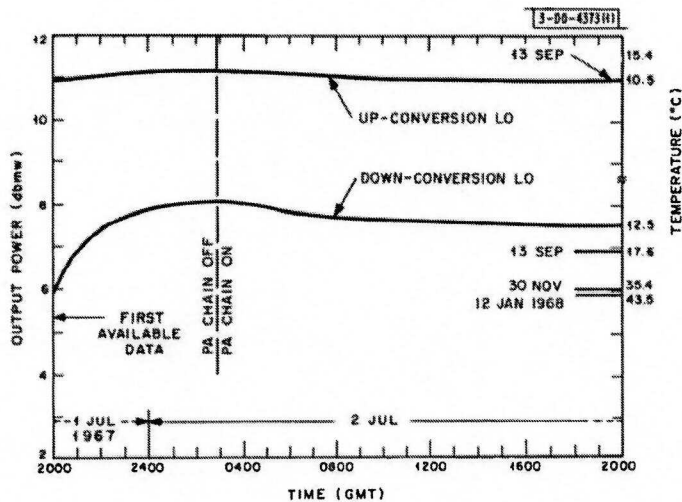

Fig. 13. Transponder local oscillators, turn-on and heating effects.

It is now apparent that these fixes did not solve all the problems. LO 2 has shown very little change in performance (excluding eclipse phenomena) since injection into orbit. Its output power level continues in fractional-db agreement with that measured at Cape Kennedy. LO 1, however, started out at an output power level agreeing approximately with the Cape Kennedy results.* Its output power soon rose almost 2 db above that level as LES-5 cooled down during the ~7-hour interval between injection into orbit and turn-on of the PA chain (Section III-A). This effect persisted through the months following launch, the output of LO 2 gradually falling as the temperature of the spacecraft increased with the approach of the winter solstice (Fig. 13). It is apparent that something else in the transponder associated with LO 1 is temperature-sensitive, and that the output of LO 1 reflects this sensitivity. By late November, the LO 1 power level had fallen back to that observed in the Cape Kennedy tests. By mid-January it had fallen a little below that level.

*The reception of telemetry from LES-5 was not successful until seven minutes after injection into orbit, so the performance of LO 1 may have been different during that time. The unit would have been somewhat warmer.

The frequency shift of LO 1, first noted 24 January 1968, was accompanied by another slight decrease in output power. Subsequent data show output power increasing as LO 1 cooled in its passage through the spring eclipses toward the summer solstice. At its minimum, LO 1 output power remained several db above the estimated level at which deficiency would be perceptible to transponder users. Both LO's possess extra performance margins. The apparent change in output-power level could conceivably be an effect produced by some shortcoming in the measuring circuit.

It cannot be said conclusively what happened to LO 1. In working with capacitors of the type used in the LES-5 LO 1 circuits for development of the LES-6 transponder, it has been noted that the values of some capacitors have changed abruptly. This effect is being investigated more thoroughly.

2. Frequency Translation

Both local oscillators were reset at Cape Kennedy in June 1967 to compensate for frequency changes caused by component aging and circuit modifications. For equilibrium temperatures predicted on the basis of thermal-vacuum testing of the LES-5 flight spacecraft, and assuming the aging process was essentially complete, the local-oscillator frequencies were predicted to be:

$$f_{LO_1} = 222.500075 \text{ MHz} \pm 35 \text{ Hz}$$

$$f_{LO_2} = 195.600145 \text{ MHz} \pm 45 \text{ Hz}$$

affording a frequency translation downward of

$$f_{TRANS} = 26.899930 \text{ MHz} \pm 10 \text{ Hz}$$

Individual uncertainties arose from the uncertainty in the estimated equilibrium temperatures of the two units. It was assumed that the frequency-vs-temperature characteristics of the two oscillators would remain similar (as observed before launch). The uncertainty in the translation frequency would then be the difference (rather than the sum) of the individual frequency uncertainties.

The two local oscillators in the transponder and the basic beacon oscillator are thermally insulated from the spacecraft platform. They required several tens of hours after full turn-on of the PA chain to reach equilibrium temperature. After that time (excluding eclipse phenomena), these oscillators gradually became warmer as LES-5 approached the winter solstice.

If precise information is sought, allowance must be made for the two-way Doppler frequency shift. The data from the Lexington terminal must be corrected by amounts corresponding to the:

- a. Inclination of the orbit with respect to the earth's equatorial plane.
- b. Slight ellipticity of the orbit, and
- c. General west-to-east drift of LES-5 in its sub-synchronous orbit.

These corrections can be obtained from data available in the LB05 Satellite Ephemeris Program printout (Appendix A). The total correction is a function of time (for the spacecraft) and of site location (assuming a stationary terminal). For a stationary terminal at the latitude (North or South) of the Lexington terminal (i.e., at $\pm 42.5^\circ$), the one-way correction at the beacon frequency does not exceed ± 50 Hz. The translation-frequency correction for such a station, therefore, does not exceed ± 100 Hz (approximately).

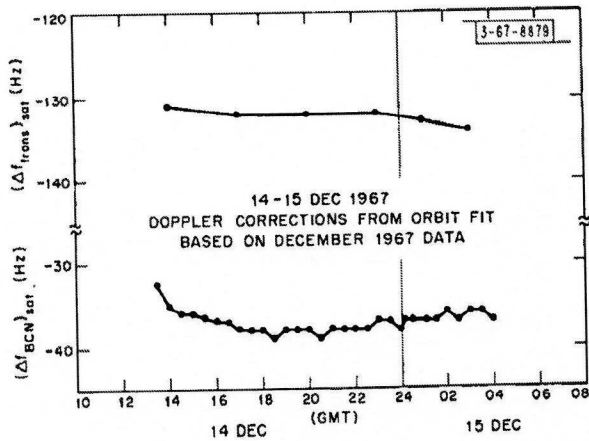

Fig. 14. Beacon and translation frequencies, departures from nominal values. Note: These characteristics are for the filters actually flown.

After this correction is made, the measurements of frequency translation made at hourly intervals throughout one day, for example, show some slight irregularities (Fig. 14). It is not presently known to what extent these variations are caused by:

- a. Inaccuracies in the ephemeris, from which the Doppler correction is calculated,
- b. Instabilities in the terminal comparison oscillator,
- c. Instabilities in the spacecraft oscillators.

The behavior of the translation frequency during the first two months in orbit is shown in Fig. 15. There was an initial transient (probably of thermal origin) that died down within a few days, revealing a second transient of much slower rate. During the last half of July and the month of August, the measured frequency translation did remain within tight bounds, but the frequency band occupied was about 90 Hz below that predicted. Some further aging effects must have taken place.

The 1967 fall eclipses (14 September through 7 November) produced sharp thermal transients in the LO's. During the longer eclipses, the LO's cooled off so much they did not recover during the ensuing sunlight periods. On the whole, the LO's ran cooler during the middle of the eclipse season, temporarily reversing the general summer-to-winter warming trend. By 22 December LO 2 had warmed up beyond +40°C. LO 1 is the warmest unit on the platform, and PA module 4 is next. The departure of LES-5 frequency translation from nominal was -126 Hz. By that time, the total observed scatter in this departure (immediate post-launch phenomena excluded) showed a spread of 80 Hz.

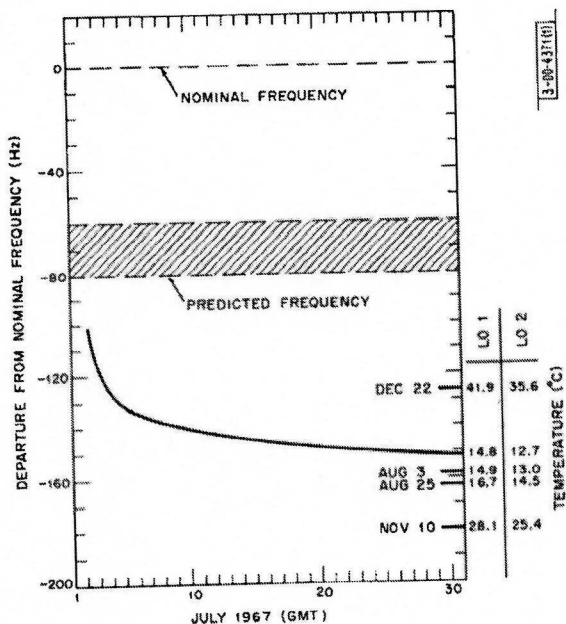

Fig. 15. Transponder frequency translation, turn-on and heating effects.

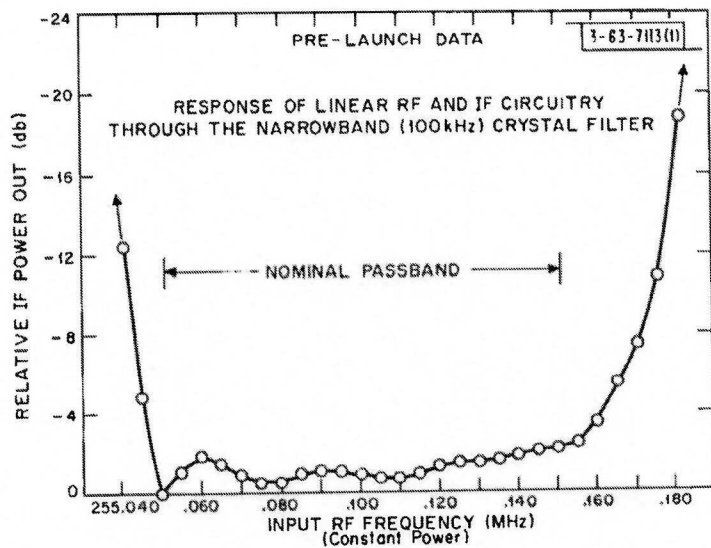

Fig. 16. Transponder's narrowband characteristics at estimated orbital temperatures - Thermal System Test 5. Note: Filter has been changed in flight unit. Its characteristics are slightly different from those shown.

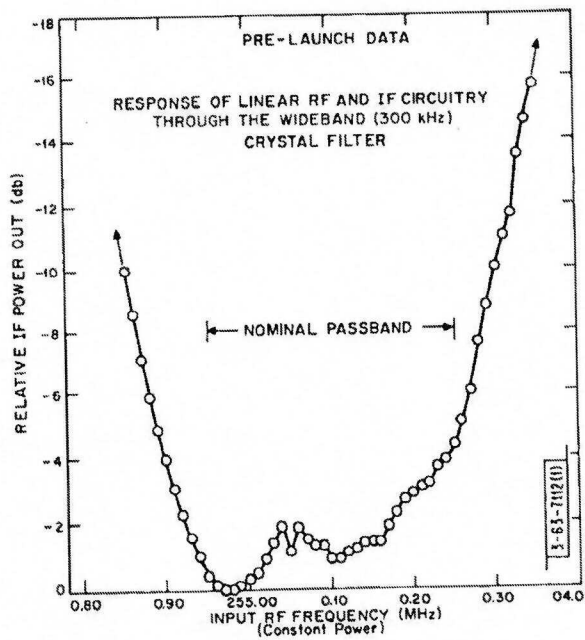

Fig. 17. Transponder's wideband characteristics at estimated orbital temperatures - Thermal System Test 5.

This number corresponds to about 3 parts in 10^6 when referred to the translation frequency of 26.9 MHz. If we assign $1/\sqrt{2}$ of this variation to each local oscillator, each is seen to have moved in frequency within a range of about 3 parts in 10^7 during this interval.

The agreeable situation just described was rudely terminated on or before 24 January 1968, when it was discovered that LO 1 had increased in frequency by about 1800 Hz (8 parts in 10^6). The translation frequency was then 1700 Hz above its nominal value. This change is more than would be expected from a crystal-controlled oscillator operating under normal circumstances. Subsequent observations of LES-5 frequency translation and X5 center frequency (Section IV-G) show no further great variation in the frequency of LO 1 (compare Section IV-D-1).

This change in translation frequency was small enough so that many terminals communicating through LES-5 did not notice its effects. Some communications experiments based on essential constancy of the translation frequency were affected by the change, however. Such experiments were continued after appropriate retuning of the terminal equipment.

All that has been written here about the LES-5 translation frequency pertains to long-term stability. No pre-launch measurements of short-term frequency stability were made on any of the flight oscillators. A boundary on the short-term frequency stability of the LO's might be estimated from test results made on the prototype units at the Syracuse University Research Corporation. The test setup available there in November 1966 provided a fine-grained frequency resolution of about 3 Hz (set by the GR 1900A wave analyzer used). The sweep rate (1 kHz/min) yielded an averaging time of 0.18 sec. To within the limits set by these observations, the frequency translation of the prototype transponder showed no measurable spectral spread. At this writing no attempts have been made by LL to measure the short-term stabilities of the LES-5 local oscillators in orbit.

E. Linear Portion of the Transponder Receiver

The RF and first half of the IF circuitry of the transponder receiver (Fig. 4) are designed to operate linearly for any signals likely to be received in orbit. The bandwidth of the transponder is set by the crystal bandpass filters embedded in this linear IF circuitry. These crystal filters are preceded by ~69 db (net) combined RF and IF gain, for margin against performance degradation as well as to provide ~60-db dynamic range. The nominal bandwidths - command-selectable - for these crystal filters are 100 and 300 kHz. It must be emphasized that although the responses of these filters drop steeply outside their transmission bandwidths, an out-of-band up-link signal that exceeds the equivalent input noise power in the spacecraft (Section IV-C) by many db may be able to overcome this skirt attenuation, capture the limiter, and commandeer a significant fraction of the transponder output power.

The responses of this linear portion of the transponder receiver (measured during pre-launch testing) are shown in Figs. 16 and 17. Such point-by-point data have been supplemented by photographs (Fig. 18) of the swept-frequency amplitude response of the transponder receiver. Phase-shift response could have been measured in the same way. The photographs show very narrow-band spurious crystal responses generally missed by the point-by-point data. It was necessary to replace the narrowband crystal filter after the data of Fig. 16 had been taken, and before that of Fig. 17. There are slight differences between the two units.

There is a telemetered test point (X20) for measurement of the power at the output of the linear IF circuitry just past the crystal bandpass filters. It has not been possible to make use

PRE-LAUNCH DATA

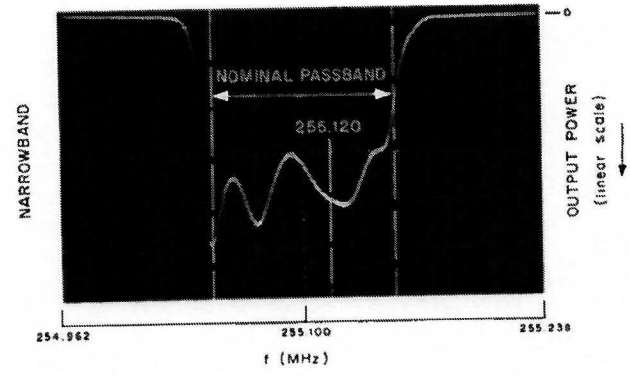

PRE-LAUNCH DATA

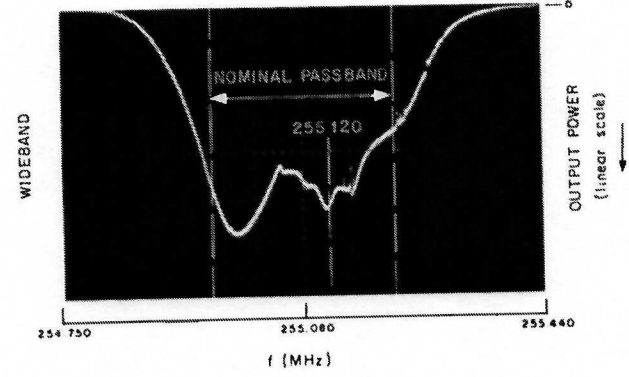

Fig. 18. Swept-frequency response of the transponder receiver, RF in to linear IF out.

of this test point for in-orbit measurements because it is comparatively insensitive. It was useful for pre-launch testing. Calibration data for this test point and the results of pre-launch system tests show that - in the narrowband mode - it is necessary to have an up-link signal stronger than -70 dbmw at the triplexer antenna port to indicate even a slight output. This test point is 5 db less sensitive in the wideband mode because of the greater insertion loss of the wideband crystal filter. Referring to the antenna-gain and path-loss numbers at the up-link frequency (Section IV-G), the RHCP EIRP of a surface terminal must exceed +100 dbmw (> 10 Mw) to activate this test point. In the absence of a surface terminal with some margin over that imposing number, performance of the linear portion of the transponder receiver must be inferred from telemetered measurements made in the nonlinear portion (Section IV-G).

F. Time Delay Through the Transponder

The time delay for passage of a narrowband frequency group through a transponder is determined primarily by the most-narrowband element in the signal-flow circuit. For the LES-5

transponder, that element is the crystal IF bandpass filter. The nominal (flat) bandwidth for this filter is 100 or 300 kHz, selectable by command.

Measurements made at LL before launch indicated that time delays through the transponder for an up-link center frequency of 255.1 MHz were about:

Narrowband	3.07 km \approx 20.48 μ sec
<u>Wideband</u>	<u>0.82 km \approx 5.47 μsec</u>
Differential delay	2.25 km \approx 15.01 μ sec

The ratio of the narrowband time delay to the wideband time delay does not agree with the intuitively expected reciprocal ratio of bandwidths. This discrepancy may have arisen because of truncation of significant portions of the power spectrum of the ranging signal by the filter skirts in the narrowband mode. The ranging signal was a biphasic-modulated pseudo-noise sequence of length $(2^{15} - 1)$ bits, the bit rate being 10^5 /sec. The width between zeros of the central lobe of its power spectrum is 200 kHz.

The transponder was operated in the narrowband mode for several months after launch, the switch to the wideband mode being made on 20 October 1967. The bandwidth has been switched back and forth several times since then to satisfy the needs of particular tests in which the transponder played a part (Section III-A; Appendix C).

The measurement of transponder time delay in orbit is derived from the orbit-fit procedure for the satellite's ephemeris. This orbit-fit procedure uses range data measured with the identical ranging signal that was used in pre-launch measurements. One of the by-products of each orbit-fit operation is a statistically determined range-bias number. This bias is the sum of the systematic range bias (or zero-set error) in the terminal equipment and the time-delay range bias in the transponder. For LES-5 in orbit the best-fit values for these (sum) biases are:

Narrowband mode	5.21 km \approx 34.73 μ sec
<u>Wideband mode</u>	<u>2.97 km \approx 19.80 μsec</u>
Differential delay	2.24 km \approx 14.93 μ sec

The differential delay, representative of the transponder alone (the terminal equipment range biases cancel out), is in excellent agreement with the pre-launch measurement. The range bias in the terminal equipment is estimated to be 2.18 km \approx 14.53 μ sec. Subtracting this number from the best-fit numbers just given above, estimated time delays through the transponder in orbit are:

Narrowband mode	3.03 km \approx 20.20 μ sec
<u>Wideband mode</u>	<u>0.79 km \approx 5.27 μsec</u>
Differential delay	2.24 km \approx 14.93 μ sec

All these numbers apply only for the ranging signal used, at an up-link frequency near 255.1 MHz (the center frequency for both narrow and wideband modes). The amplitude characteristics of the two filters are not strictly flat over their nominal bands (Sec. IV-E). There may be perturbations in their respective phase-shift-vs-frequency curves that would alter the time-delay relationships recounted above, particularly if ranging signals differing in center frequency or waveform are used. Swept-frequency phase-shift-response measurements were not made during pre-launch testing of the transponder.

The differential-delay measurement was performed again as part of the bandwidth switch of 23 April 1968. The results were consistent with those just given.

G. Hard-Limiting Characteristics of the IF Unit and RF Transponder Transmitter

IF circuitry after the crystal bandpass filters comprises a broadband, multistage, variable-gain amplifier and limiter. The up-converted output of this circuitry, filtered to eliminate harmonic zones of the mixer output that are not of interest, increases only slightly (0.5 db) from low to high signal-to-noise-power ratio into the limiter (and thus, from low to high signal-power-to-noise-power-density ratio at the input to the transponder receiver). The several sections of the RF transmitter that follow the up-converting mixer are operated in a markedly nonlinear fashion, with saturation of successive amplifying stages. This procedure yields highly efficient conversion of DC power to RF. It also completes the hard-limiting process. To within the limits of observation, the total average-power level at the output of the PA chain is independent of the signal-to-noise-power-density ratio at the input to the transponder receiver.

The proportion of transponder output power that is devoted to a particular communication tone going through it is, however, strongly dependent on the signal-to-noise-power ratio. Figure 19 shows results from pre-launch measurements of this relationship for the two transponder bandwidths. A very strong up-link tone monopolizes the down-link output power of the

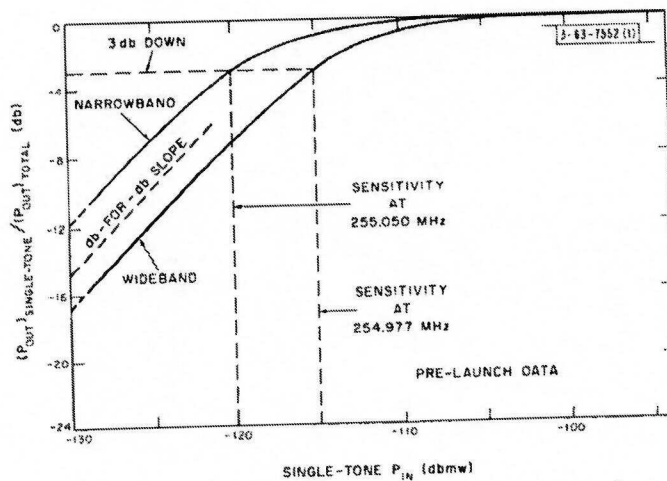

Fig. 19. Transponder's limiting characteristics - Flight System Test. Note: Narrowband filter has been changed in flight unit. Its characteristics are slightly different from those shown here.

transponder. Based on the theory of the ideal bandpass limiter,^{4,5,11} there is a 3-db increase in the output (transmitted, down-link) signal-to-noise-power ratio over the input (received, up-link) signal-to-noise-power ratio in this case. On the other hand, a very weak up-link tone is scarcely noticed among the transponded noise. Theory tells that the ideal bandpass limiter introduces a ~1-db decrease in signal-to-noise-power ratio in this case. Below the knees of the curves (see the next paragraph) the saturation curves drop off at a db-for-db rate, until a floor is reached corresponding to the transmission of transponder front-end noise in the frequency window used for observation.

Of particular interest is the situation, near the knee of each curve, in which one-half the output power of the transponder is noise, the other half being concentrated in a down-link tone of equal average power. This same relationship must hold for the input to the limiter, because

unity (0db) signal-to-noise-power ratio is unchanged by an ideal bandpass limiter. The input to the limiter is the output of the linear RF and IF circuitry (Section IV-E). Assuming that the combined linear RF and IF gain is constant across the RF/IF signal band concerned, the equivalent input noise power of the transponder ($P_n = kT_{eq}FB$, Section IV-C) must then be equal to the power (P_r, P_{in}) of the single up-link tone at the input to the transponder receiver.

In Section IV-E, the combined linear RF and IF gain is not constant across the band. This variation must be reckoned if an absolute measure of the equivalent input noise power is desired. In practice, it is more convenient (and equally illuminating) to measure sensitivity point-by-point across the RF/IF passband. As noted, the critical input power level (up-link tone at a given frequency) is that for which the corresponding output power level (down-link tone plus noise in a frequency window much narrower than the transponder bandwidth) is 3 db down from full output power. The full-output-power reading is established by transmitting an up-link tone strong enough to capture the limiter and concentrate essentially all of the down-link output power into the down-link tone.* A measurement of this sort can readily be made after the spacecraft is in orbit, given the RHCP EIRP of the terminal, the range to the spacecraft, and the up-link-frequency gain of the spacecraft antenna. Down-link characteristics need not be known for this measurement, though they should be constant for any particular test period.

The sensitivity of the transponder was measured by this method throughout system testing at Lexington and after a crystal-filter change at Cape Kennedy before launch. Readings were taken at the highest in-band peak and the lowest in-band valley for both narrow and wideband widths (Figs. 16 and 17). The final pre-launch results were:

<u>Narrowband</u>	<u>Frequency</u>	<u>P_r, P_{in}, P_n</u>
Lower-edge peak	(255.052 MHz)	- 121.1 dbmw
Mid-band valley	(255.094 MHz) }	- 118.2 dbmw
Upper edge	(255.146 MHz) }	
<u>Wideband</u>		
Lower-edge peak	(254.977 MHz)	- 115.4 dbmw
Upper edge	(255.250 MHz)	- 110.5 dbmw

The pre-launch saturation curves (Fig. 19) were measured at the frequencies of peak sensitivity.

After LES-5 was operating in orbit, its passband characteristics were measured in both narrow and wideband modes. Two additional precautions had to be taken:

1. If conditions of unsteady propagation occurred (Section VIII), it was useless to attempt precise measurements of transponder sensitivity. The observed enhancement or fading of the down-link signal was accompanied by similar (perhaps uncorrelated) variation in the up-link propagation channel. It was, therefore, necessary to avoid such periods when sensitivity measurements were to be made.
2. The ± 0.5 -db spin-modulation effect noted in the antenna pattern at the down-link frequency (Section IV-B) is accompanied by a similar effect at the up-link frequency. The spin period of LES-5 in orbit was about 5.2 seconds in July 1967. It is necessary to use many tens of seconds of smoothing when estimating the peak and 3-db-down values of the down-link tone during a sensitivity measurement.

* Conceptually, this measurement is equivalent to one in which we measure the input-power level (up-link tone) for which the output-noise-power level in a frequency window much narrower than the transponder bandwidth - well separated from the down-link tone - drops 3 db from the level with no up-link tone. The first approach seems a little easier in practice.

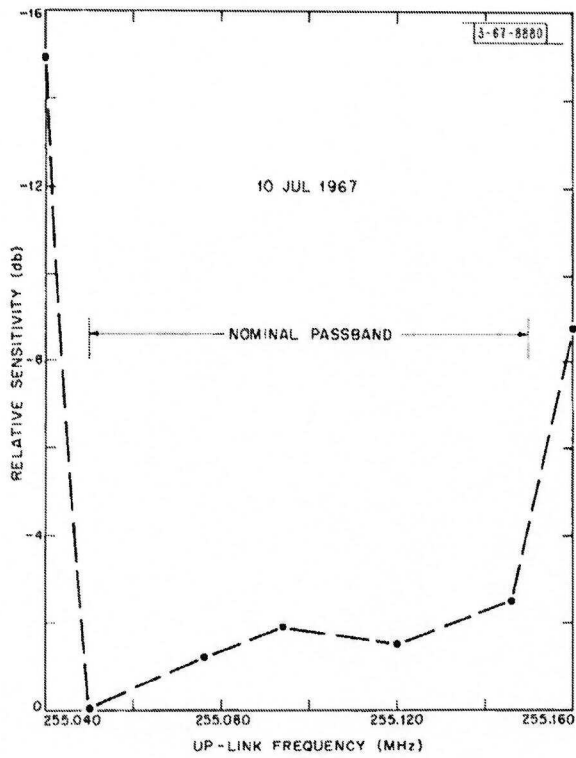

Fig. 20. In-orbit transponder sensitivity, narrowband (100-kHz) mode.

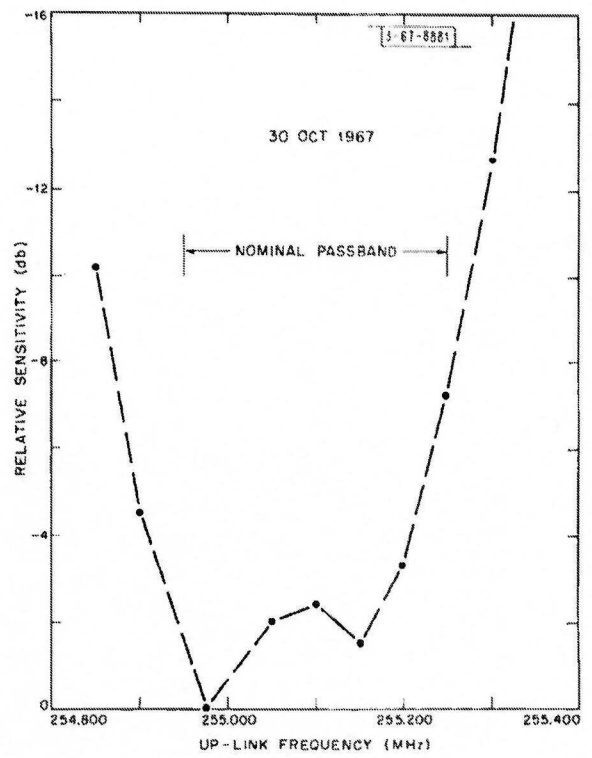

Fig. 21. In-orbit transponder sensitivity, wideband (300-kHz) mode.

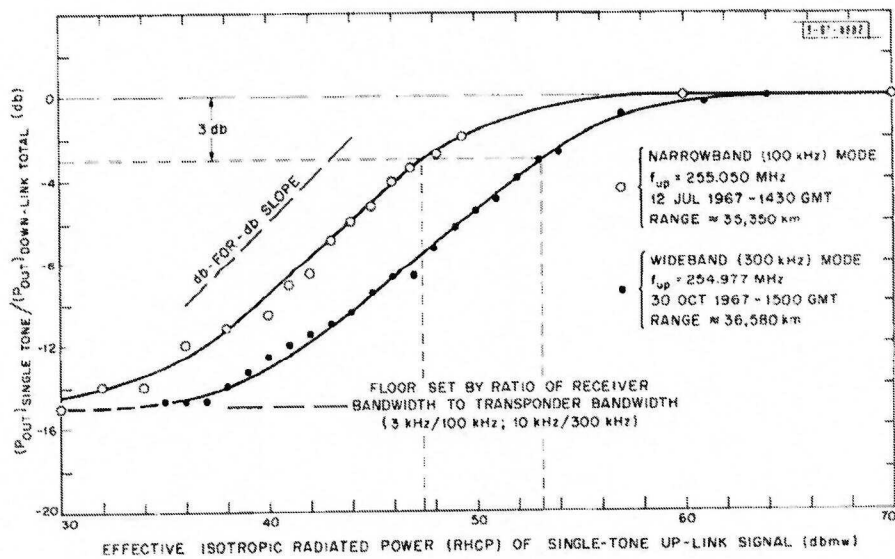

Fig. 22. In-orbit transponder limiting characteristics.

The results of the in-orbit measurements of passband shape (Figs. 20 and 21) are seen to be in general agreement with the results of pre-launch measurements.

Saturation curves (Fig. 22) were measured in orbit near the frequencies of peak response in each bandwidth mode. These data were taken by the same technique used to measure 3-dB-down-through-the-limiter sensitivity. The precautions of propagation steadiness and data smoothing mentioned above apply here, too. These curves show the saturation characteristics of the complete transponder at the specific frequencies. Curves could be taken at other frequencies. The abscissa for Fig. 22 (terminal RHCP EIRP, at particular ranges) is convenient in some applications. For completeness, similar data are plotted in Fig. 23 with (calculated) P_r at the spacecraft as the abscissa. For interest, (calculated) spacecraft RHCP EIRP is used as the ordinate in Fig. 23.

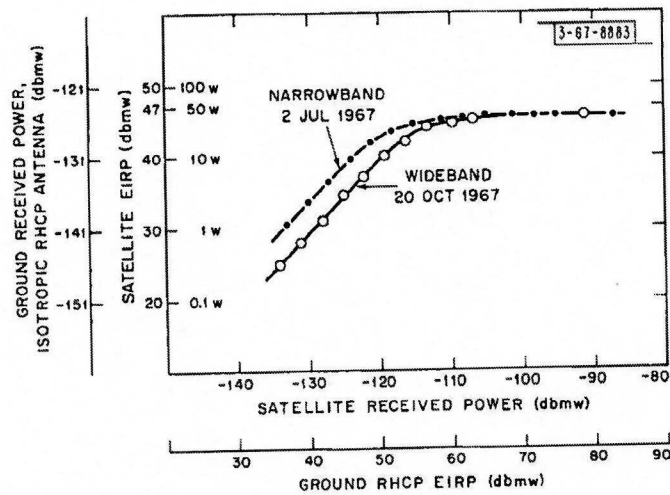

Fig. 23. Transfer curve.

It is of interest to compute the sensitivity of the transponder in orbit from the terminal RHCP EIRP's required for the 3-dB-down points. These numbers are taken from Fig. 22. The path losses are calculated from the ranges at the time of observation. The gain of the LES-5 antenna at the up-link frequencies is taken to be $+2.2 - 0.6 = +1.6$ db with respect to a lossless RHCP isotropic antenna (Section IV-B1) in the direction of Lexington, 7° off-beam.

Quantity	Narrowband Peak (12 July 1967)	Wideband Peak (30 October 1967)
Required terminal RHCP EIRP	+47.5 dbmw	+53.2 dbmw
(Path loss) ⁻¹	-171.6 db	-171.9 db
LES-5 antenna gain	+1.6 db	+1.6 db
Up-link power at the tri-plexer antenna port (P_r)	-122.5 dbmw	-117.1 dbmw
Pre-launch result (P_r) above	-121.1 dbmw	-115.4 dbmw
Discrepancy	-1.4 db	-1.7 db

These disagreements are within the accuracy of the combined measurements. It would be surprising if the sensitivity of the transponder were better in orbit than during ground tests. That circumstance is not inconceivable however (Section IV-C). Alternatively, it is possible that the up-link-frequency RHCP gain of the Lexington terminal antenna is larger than the number used (+24 db). If so, the abscissa scales on Figs. 22 and 23 should have their numbers increased accordingly. In any event, the sensitivity of the LES-5 transponder in orbit appears to have suffered no degradation from its pre-launch value.

[This section was written before the circuit failure in the first RF amplifier, associated with the eclipse of LES-5 by the earth on 18 March 1968 (Appendix B). Its principal consequence is a degradation in transponder sensitivity of approximately 17 db at the up-link frequency. The associated drop in linear RF gain (approximately 21 db at the up-link frequency) is compensated for by saturation margin in the gain of the IF limiter. The low-level down-link signal continues to be adequate – and in the desired ratio to the linearly combined beacon signal – to drive the PA chain into saturated operation.⁶

The saturation characteristics of the transponder receiver through the IF variable-gain amplifier and limiter can be measured at one particular frequency via telemetered test point X5. The output of this test point is proportional to the average power in a very narrowband (~ 1 kHz) crystal-tuned filter circuit at the output of the IF limiter. The up-link frequency to which this test point responds also serves as an indication of the frequency of down-mixing local oscillator 1 (Section IV-D2).

The response of test point X5 in each bandwidth mode is shown in Fig. 24. The ordinate is given in corrected numerical counts from LES-5 telemetered data and in IF output power. The abscissa is the estimated RHCP EIRP of the Lexington terminal for LES-5 about 36,000 km away. From pre-launch calibrations, the response of X5 for a very strong up-link signal in its passband is a telemetry reading of about 160 count, corresponding to +5.6 dbmw. The reading corresponding

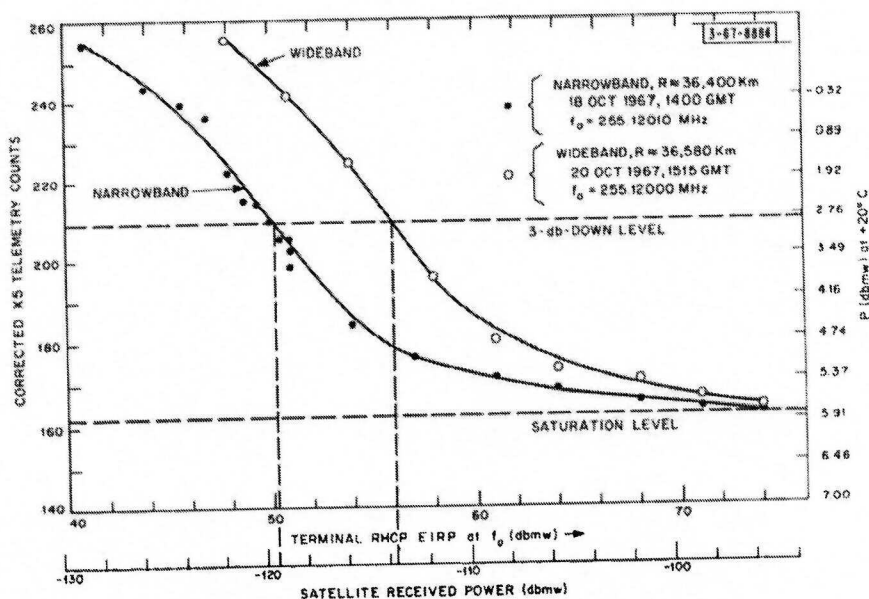

Fig. 24. Test point X5 response.

⁶ Note added during proofreading: The transponder suddenly regained its original sensitivity on 14 November 1968.

to +2.6 dbmw (3-db down) is about 209 count. This relationship is the basis for routine measurement of LES-5 transponder sensitivity in orbit via the telemetry system. The quality-control variable is taken to be the up-link transmitter power from the Lexington terminal that is required for an X5 reading of about 209 count. Allowance must be made for slight differences in range from observation to observation as LES-5 moves in its orbit. Observations made at very low elevation angle are less reliable, for there may be increased atmospheric attenuation there as well.

It has been proposed to use readings from test point X5 to measure received power (P_r) in the transponder receiver (Fig. 24). It is essential that the signal to be measured is in the narrow frequency band to which X5 is tuned ($f_o \approx 255.120$ MHz). A reading would be available via LES-5 telemetry every 10.24 sec. The relationships (for narrowband, for wideband) between P_r (in dbmw, say) and telemetered data (in arbitrary count units, from 000 to 255) are, of course, independent of the range from the signal transmitter to the spacecraft. There may be some variations in these relationships with spacecraft temperature, however. The P_r abscissa scale on Fig. 24 is established by the following calculations for the Lexington terminal. It is assumed that the test signal at f_o is the only up-link signal in the transponder.

Quantity	Narrowband Mode (255.12010 MHz) (18 October 1967)	Wideband Mode (255.12000 MHz) (20 October 1967)
Up-link RHCP EIRP	+50.2 dbmw	+56.0 dbmw
(Path loss) ⁻¹	-171.9 db	-171.9 db
LES-5 antenna gain	+1.6 db	+1.6 db
Up-link power at the triplexer antenna port (P_r)	-120.1 dbmw	-114.3 dbmw
X5 reading (counts)	~ 209	~ 209

Finally, the sensitivity measurements made with the benefit of data telemetered from test point X5 are shown consistent with the over-all sensitivity measurements made on the down-link signal. Corrections must be made for variation of transponder sensitivity across the bands of the two crystal filters. From Figs. 16, 17, and 18 for an up-link frequency of 255.120 MHz, the wideband mode is down about 2.4 db from its peak sensitivity, whereas the narrowband mode is down only about 1.5 db from its peak sensitivity.

Quantity	Narrowband Mode	Wideband Mode
(P_r) _{X5}	-120.1 dbmw	-114.3 dbmw
Sensitivity Correction	-1.5 db	-2.4 db
(P_r) _{X5} corrected	-121.6 dbmw	-116.4 dbmw
compared with		
(P_r) over-all measurement	-122.5 dbmw	-117.1 dbmw
Discrepancy	+0.9 db	+0.7 db

This disagreement is within the accuracy of the combined measurements.

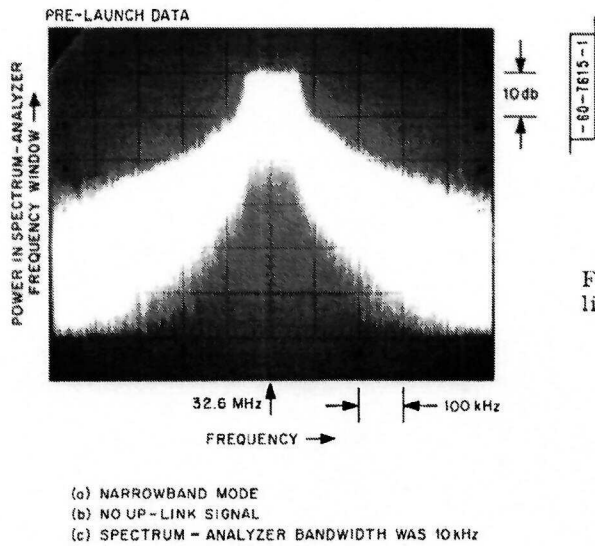

Fig. 25. Output power spectrum of the IF limiter in the prototype transponder.

Price has shown⁶ that the power-spectral density of the output of an ideal bandpass limiter (that is, a sinusoid of constant amplitude, with uniformly distributed zero crossings) is essentially flat over the frequency band concerned, making a transition to an asymptotic rate of fall-off (30 db per decade of half-bandwidth) above and below that band. Figure 25 shows this phenomenon for the output of the IF limiter in the prototype LES-5 transponder. The "flat" bandwidth is set by the preceding narrowband crystal filter. The spectrum for operation in the wide IF bandwidth is similar, but scaled in power-spectral density and frequency spread to correspond to the same total power (the power in the filtered limiter output).

The signal transformations afforded by a hard-limiting transponder such as that in LES-5 in the presence of several simultaneous up-link tones are considerably more complex. Some comments on this matter with respect to effects on the beacon signal are given in Section V.

H. Transponder Transmitter

The LES-5 transponder transmitter (PA chain) is of particular interest as a highly efficient solid-state DC-to-RF power converter. The significant features of the circuit design have been presented in another report⁷. Pre-launch tests showed that for operation at +20°C and an input RF power of 150 mw at 228.2 MHz, the output power was 42 w, with a DC-power requirement of 63.2 w. This result corresponds to ~67 percent DC-to-RF power-conversion efficiency. The saturation characteristics were such that for a 3-db drop in input RF power, the output power dropped by 0.7 db.

Telemetered testpoint data from the in-orbit PA chain indicate this performance has been achieved. The output power was slightly higher on launch day at turn-on, LES-5 having cooled down substantially after 7 hours in orbit. The output power was slightly less during the winter solstice when the temperatures of spacecraft units were at their highest. The total observed summer-to-winter variation is less than 1 db.⁸

*See Appendix D for recent data.

Of course, not all of the PA-chain output power is radiated by LES-5. It is estimated that about half of it is dissipated aboard the spacecraft by virtue of ohmic and impedance-mismatch losses in the ferrite load isolator, the dual-directional coupler, the triplexer, the power-dividing networks, and the elements of the antenna system, as well as in the interconnecting coaxial cables. The calculated effective isotropic radiated power of LES-5 is discussed in Section IV-A.*

Signal-limiting provided by the saturated amplifying stages in the transponder transmitter was discussed in Section IV-G. So long as the PA chain receives from the transponder receiver only a single down-link tone embedded in noise, things work as described. As noted in Section V, the addition of the beacon signal to the low-level down-link signal gives rise in the PA-chain output to intermodulation product signals in the vicinity of the two true signals. Representative spectrum-analyzer pictures are shown in Figs. 26 through 31.

The transponder transmitter can be turned on and off by command. Turning off the PA chain effectively turns off the beacon signal, including its parallel channel of telemetry information (Section V).

V. BEACON SYSTEM

The LES-5 beacon signal is generated in synchronism with the telemetry signal (Section VI). The beacon bit stream flows at a rate of 800/sec. The format repeats its gross features at a rate of 100/sec. The content of the eight 1.25-msec time slots is:

- Slot 1 - Framing pulse (logical 0)
- Slot 2 - Shift-register sequence of length 25
- Slot 3 - Shift-register sequence of length 27
- Slot 4 - Shift-register sequence of length 29
- Slot 5 - Shift-register sequence of length 31
- Slot 6 - Shift-register sequence of length 32
- Slot 7 - Alternate 0's and 1's
- Slot 8 - Telemetry bit stream.

The super-sequence (slots 2 through 6) has an over-all period greater than one day. Under suitable circumstances, beacon timing can be acquired by a small terminal receiver within a minute.

The beacon carrier signal (at 228.43 MHz) is frequency-doubled from a basic temperature-compensated, crystal-controlled, transistor oscillator. This carrier is biphase-modulated ($\pm 90^\circ$) by the beacon bit stream. The modulated beacon signal is then combined linearly with the low-level RF down-link in the transponder (Fig. 4). This beacon signal can be commanded on or off.

When the beacon signal is on, a number of intermodulation products are formed in the non-linear transponder transmitter (Section IV-H). Figure 32 shows the spectrum of the transponder output for a strong up-link signal at 255.100 MHz with the beacon on (compare Figs. 27 and 30). The highest peak is the down-link signal at 228.200 MHz. The next highest peak (just to its right) is the beacon signal (228.430 MHz). The other peaks to the left and right of these two are the intermodulation products. The spacing between adjacent peaks is equal to the spacing between the down-link signal (whatever it may be at a given time) and the beacon signal.

*Appendix D.

These spurious signals are impressive on the logarithmic display of the spectrum analyzer, but their power content is small. Turning the beacon on drops the down-link tone by less than 1 db. Roughly half of the output power subtracted from the down-link tone comes out in the beacon signal proper. The remainder appears in the intermodulation products.

Under normal operating conditions, the ratio of a strong down-link carrier signal to the beacon signal in the output of the transponder transmitter was planned to be approximately +10 db. The in-orbit value of this ratio was found to be +11.5 db. The source of this discrepancy has not been found. The 1.5-db reduction in beacon-signal power has been found not to be a handicap for small terminal operation.

The EIRP in the beacon signal can be calculated directly or obtained by subtracting 11.5 db from the corresponding down-link EIRP (Table 1). The strength of the beacon signal is independent of the S/N ratio for a single tone passing through the transponder. If two or more tones are present, the situation becomes more complex. For example, it is possible to put in two suitably chosen strong up-link tones lying within even the narrowband of the transponder and experience serious disruption of the beacon signal by virtue of intermodulation effects among the three signals in the PA chain.

If there is no strong up-link tone in the transponder, the down-link signal has a power spectrum similar to that of Fig. 25. The intermodulation effects between this broad-spectrum signal and the much-narrower-band beacon signal spread out the spikes of Fig. 32 into a continuum. The single spectral spike at the beacon frequency can still be discerned provided a sufficiently narrow spectrum-analyzer bandwidth is used. Figures 26 through 31 are representative spectrum-analyzer pictures taken with LES-5 in orbit.

Many of the remarks made in Section IV-D about the transponder LO's also apply to the beacon carrier oscillator (Fig. 14). It is essential to correct for one-way Doppler-shift effects if precise results are to be obtained from frequency measurements (Appendix A). The beacon chassis is thermally insulated from the platform by standoffs and a separate aluminized plastic sheath. It changes temperature rather slowly by comparison with other units on the LES-5 platform.

The basic beacon carrier oscillator was received from the vendor late in 1966. Its frequency-vs-temperature characteristics were monitored repeatedly during environmental acceptance testing. After system testing began, the beacon carrier frequency was reset for compatibility with terminal equipment on 1 April 1967. Observation of the flight beacon oscillator during the six-month period between receipt and final testing at Cape Kennedy suggested that the carrier frequency at thermal equilibrium would be 228.429980 MHz (20 Hz below nominal), assuming the aging process was essentially complete.

After launch, the beacon frequency could not be measured until after the PA chain was turned on. Figure 33 indicates that the beacon crystal oscillator proper continued to cool down for several hours after the PA chain was turned on. This is not surprising; the oscillator sits atop the modulator box. After a time, though, the heat dissipation from the PA modules and other high-power units began to take effect. The direction of frequency change reversed, and the frequency stabilized 10 to 15 Hz below the predicted value. As the pre-eclipse weeks passed, the spacecraft became generally warmer with corresponding reductions in the beacon carrier frequency. By 5 September (shortly before the eclipse season started), the carrier frequency was 90 Hz below nominal. The frequency of the beacon carrier appeared to be following the temperature characteristic of the oscillator as measured before launch.

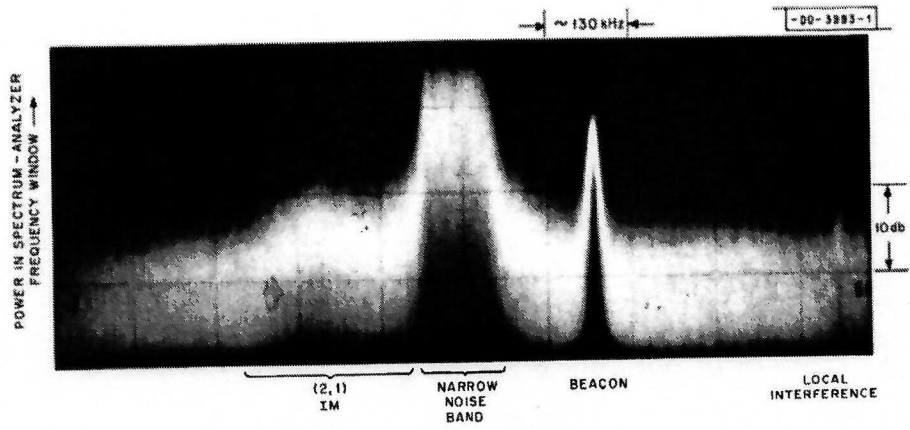

Fig. 26. Down-link signals I: Satellite receiver noise, narrowband mode.

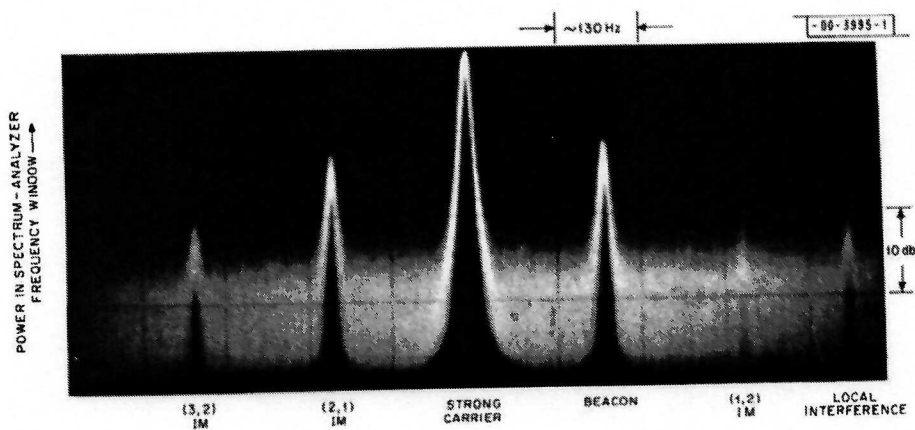

Fig. 27. Down-link signals II: Single strong tone through transponder, narrowband mode.

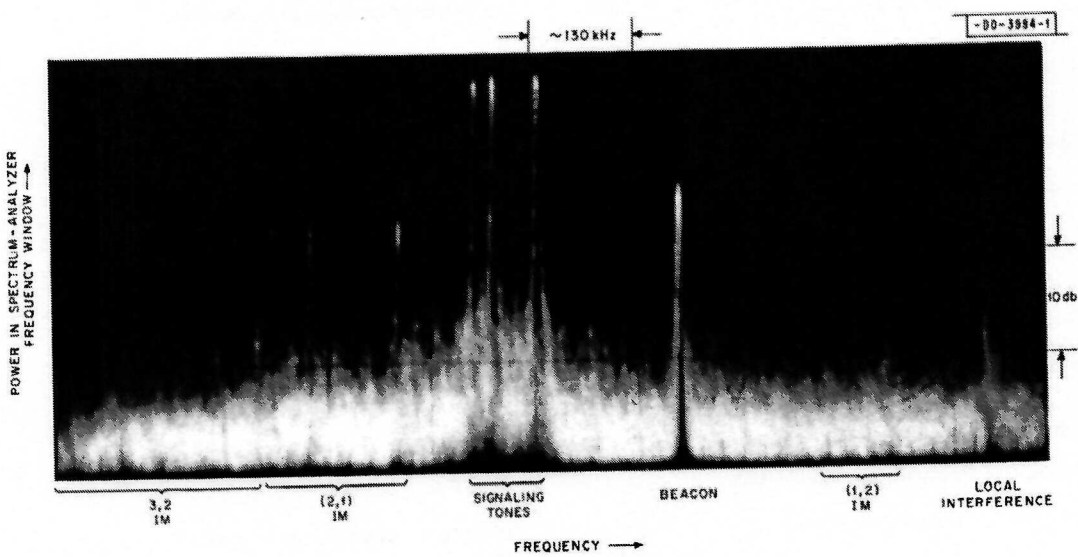

Fig. 28. Down-link signals III: Three-pair FSK tones through transponder, narrowband mode.

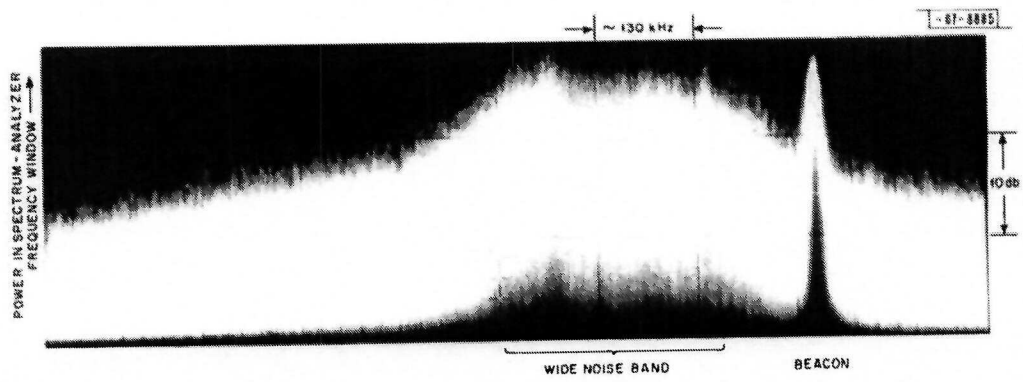

Fig. 29. Down-link signals IV: Satellite receiver noise, wideband mode.

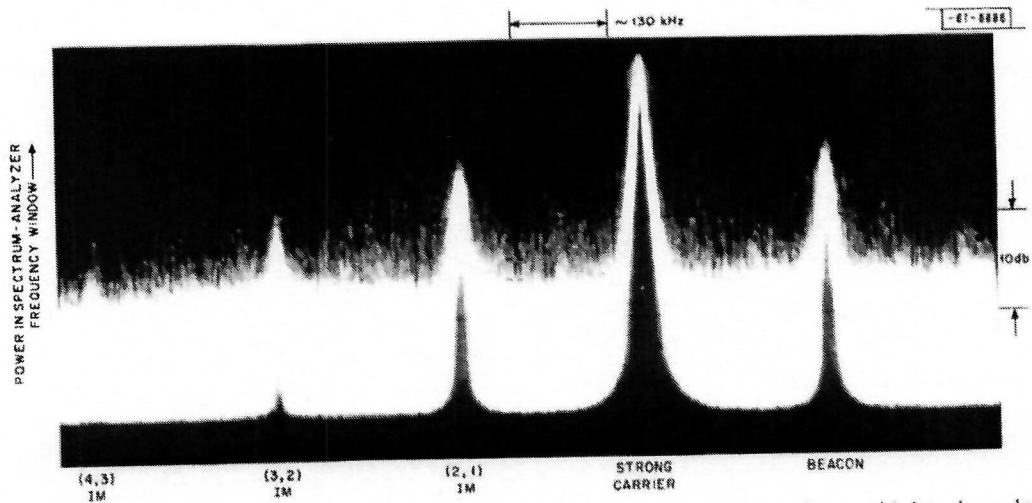

Fig. 30. Down-link signals V: Single strong tone through transponder, wideband mode.

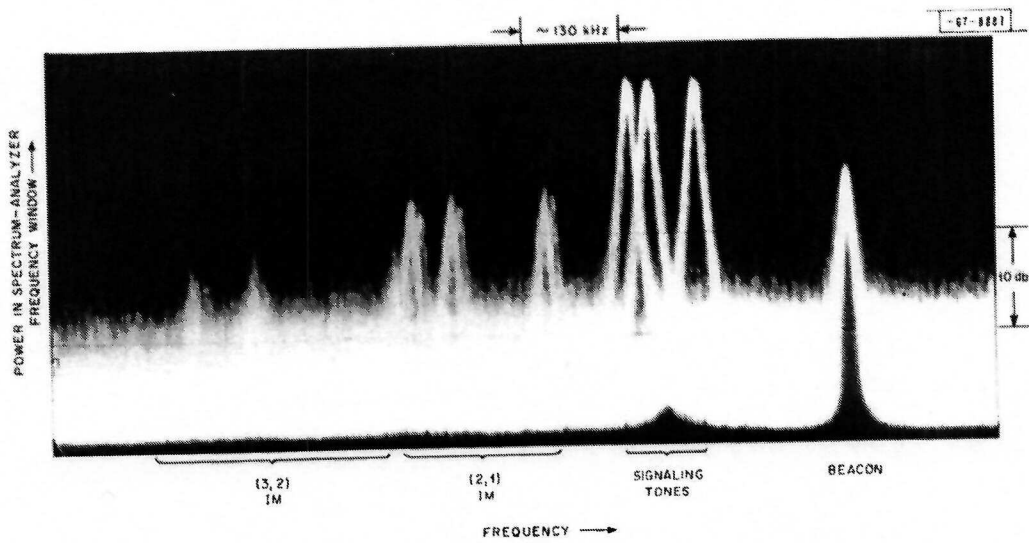

Fig. 31. Down-link signals VI: Three-pair FSK tones through transponder, wideband mode.

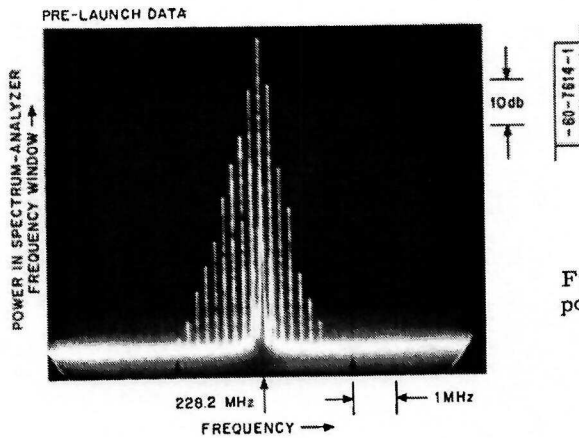

Fig. 32. Transponder-transmitter output-power spectrum.

- (a) BEACON ON
- (b) STRONG UP-LINK SIGNAL AT 255.100 MHz
- (c) SPECTRUM - ANALYZER BANDWIDTH WAS 3kHz

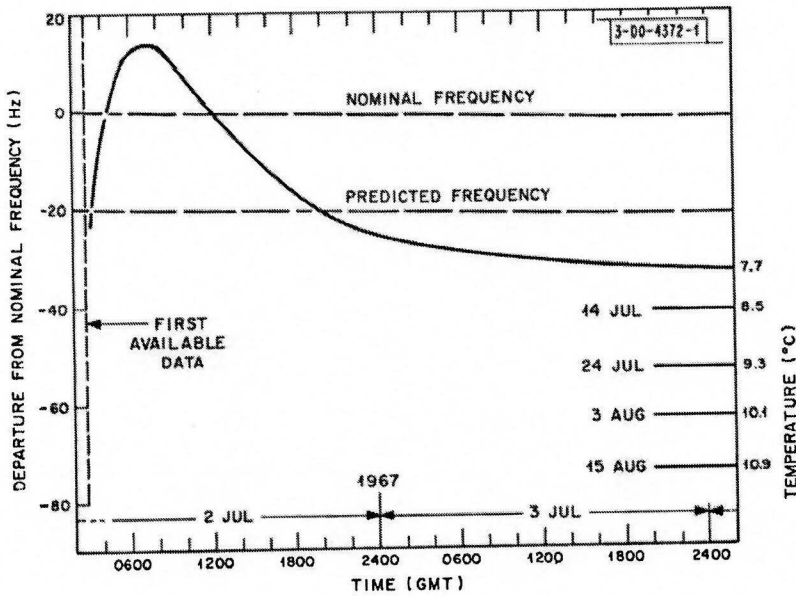

Fig. 33. Beacon-carrier-frequency turn-on and heating effects.

During the fall eclipse season, the thermally insulated beacon carrier oscillator was subjected to transients similar to those discussed for the LO's in Section IV-D. After eclipses ceased, the unit stabilized at a higher temperature and warmed even more as the winter solstice approached. The beacon carrier frequency was observed to move more than 60 Hz above nominal during this time. At the end of the spring eclipse season, the beacon carrier frequency was more than 200 Hz below nominal. Excluding a few wild points that may have been introduced by operating errors in the terminal, the beacon carrier frequency has been observed to remain within 2 parts in 10^6 total variation. This summary of behavior includes nonstandard operating conditions in the post-launch and eclipse periods.

No pre-launch measurements were made of the short-term stability of the beacon carrier oscillator. At this writing, no attempts have been made from LL to measure this characteristic in orbit.

VI. TELEMETRY SYSTEM

The LES-5 telemetry system (Fig. 4) was planned originally as a completely separate system transmitting at 236.75 MHz. As a backup, the telemetry data were included in the modulation of the beacon signal at 228.43 MHz (as part of the timing signal, Section V). The Laboratory's Westford and Camp Parks terminals are instrumented for telemetry data collection near 237 MHz (standard for LES-1, -2, and -4), and the Lexington terminal can obtain telemetry data from the beacon signal.

When the intermodulation product problem between the telemetry transmitter (at 236.75 MHz) and the transponder transmitter (at 228.2 MHz) became apparent before launch, it was planned that the telemetry transmitter was to be ON at injection time and the transponder transmitter to be OFF. After acquisition of the telemetry signals and a determination of the satellite status and orbit, the telemetry was to be turned OFF and the transponder turned ON by means of ground-station command. Because of the timing problem (Section III-A) it was not possible to send these commands until the problem cleared some seven hours after injection. Therefore, telemetry data were received at the Westford station and transmitted to Lexington via telephone line for quick-look readout and recording during that interval.

A. Frequency Stability

The telemetry transmitter generates a carrier signal that has been frequency-doubled from a basic temperature-compensated, crystal-controlled, transistor oscillator. The doubled carrier is biphase-modulated ($\pm 90^\circ$) by the 100/sec telemetry bit stream. Observations of the telemetry carrier frequency at the Westford terminal (Table 4) include the apparent (received) frequency (the phase-locked terminal LO was divided by 4 and counted), the Doppler correction, and the corrected (transmitted) frequency (Appendix A).

Time (GMT)	Received Frequency (MHz)	Doppler (Hz)	Transmitted Frequency (MHz)
1 July 1967			
2000	236.750,176	-15	236.750,191
2210	192	-8	200
2236	208	-5	213
2335	224	+1	223
2 July 1967			
0040	240	+8	232
0140	248	+15	233
0238	256	+20	236
032129	OFF		

B. Intermodulation Products Formed between Outputs of the Telemetry and Transponder Transmitters

As noted in Section IV-H (see also Fig. 32), passage of the sum of the low-level down-link signal and the beacon signal through the well-saturated PA chain results in the formation of a

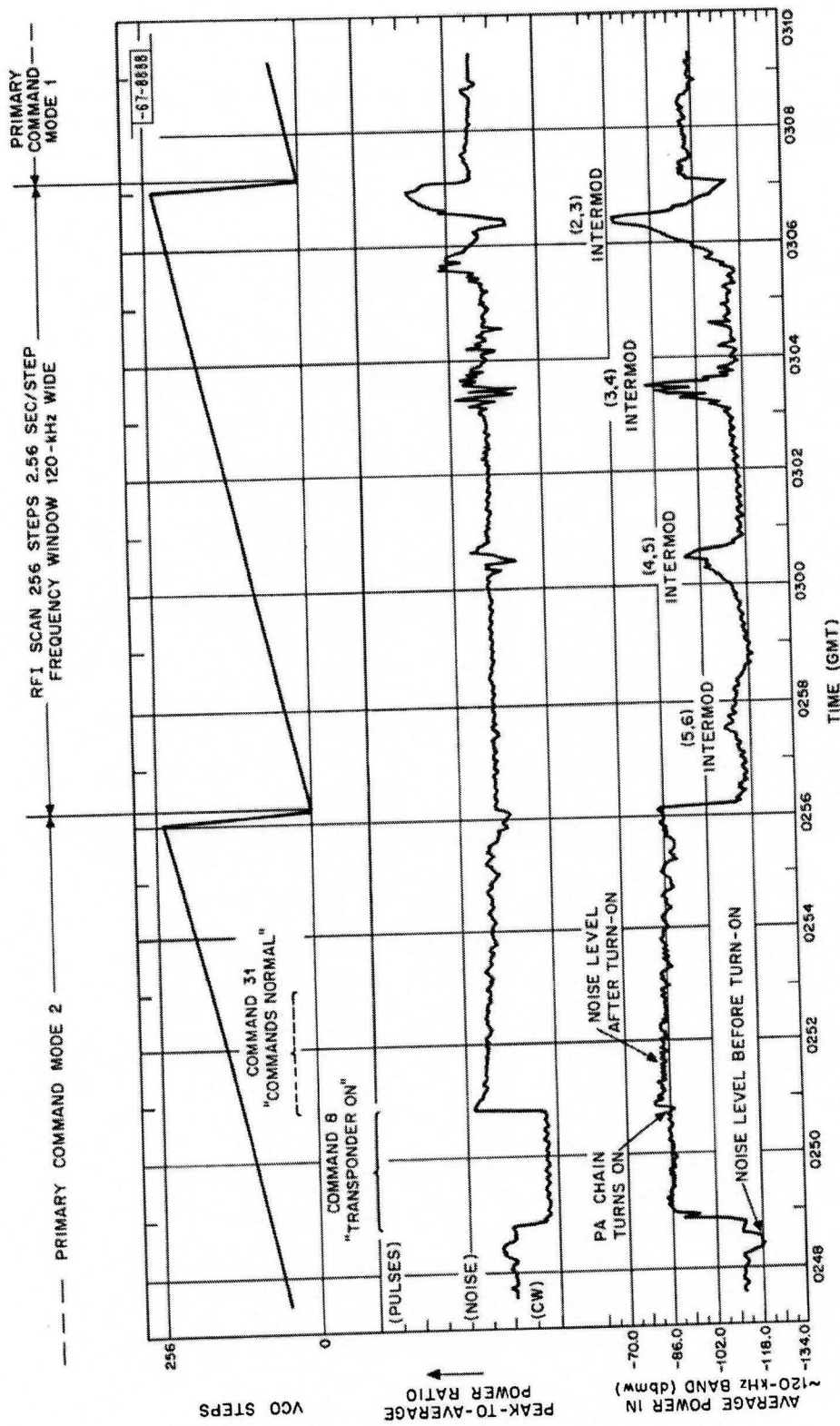

Fig. 34. RFI data.

collection of intermodulation product signals surrounding the two true signals. The presence of these extra signals is part of the price that is paid in LES-5 for efficient conversion of DC to RF power in the PA chain. They were anticipated from the start. They cause no trouble.

There is a second potential source of intermodulation product signals that can cause trouble, however. Referring to Fig. 4, the high-level output signals from the PA chain pass through triplexing and antenna system circuitry along with the output signals from the telemetry transmitter. If there are electrical nonlinearities in the RF circuitry common to the transponder receiver and transmitter and the telemetry transmitter, the way is open for the formation of intermodulation product signals that can interfere with proper receiver performance. The frequency allocations for LES-5 are such that the upper fifth-order product between these two high-level signals ($f_{IM} = 3f_{TLM} - 2f_{PA}$) is uncomfortably near the receive band. With noise in the transponder receiver, the spectrum tail of this fifth-order product (widened by the factor of 2) can extend across the receive band, adding a substantial amount of noise power and correspondingly decreasing the transponder sensitivity to true up-link signals.

To be sure, these are very small effects on an absolute scale. Taking the average noise power in the LES-5 narrowband to be -120 dbmw (Section IV-C) and the output of the PA chain in the triplexer to be $+46$ dbmw (Section IV-10), this concern is seen to be about effects that are more than 166 db below the level of the outstanding signal. Measurement of these effects is difficult, requiring the equivalent of a triplexer and transponder receiver.

Measures taken during the construction of LES-5 to eliminate intermodulation-product effects of this sort were not successful. System testing of the complete spacecraft at Lexington showed significant, varying, sensitivity-degradation effects from the formation of these intermodulation products. The solution adopted was to launch LES-5 in a pre-set condition corresponding to having the PA chain turned OFF and the telemetry transmitter turned ON. As soon as LES-5 was inserted into orbit and had started to operate, the telemetry system was to give a report of spacecraft status. At an appropriate time, the telemetry system was to be turned OFF and the PA chain turned ON. It was feared that if they were both ON at the same time, intermodulation products might interfere with reception of the command to turn OFF the telemetry transmitter.

As noted in Section III-A, this operating procedure was abandoned after in-orbit timing problems with the LES-5 command system were discovered. When the timing improved, the PA chain was turned ON while the telemetry transmitter was still going, after which the telemetry transmitter was successfully turned OFF. Intermodulation-product signals from this source then ceased to exist.

The events of these stirring minutes are graphically presented in Fig. 34 that shows the principal outputs of the RFI instrument. Briefly, the RFI instrument reports by telemetry the power levels of primary command signals received by LES-5 and provides a spectrum analysis of received signals in the 253 to 283 MHz region. Timing is normal (single rate). The uniform progress of the command timing ramp (or stepper) through its 256 steps (one-fourth are telemetered out via CL-2) in about 11 minutes is shown in the top frames. The bottom frames show the average-power reading (RFI-1). In the ramp segment at left, the system is in primary command mode 2. The noise level is represented by the dip at about 02:48:30. The command "Transponder ON" (Section III-A) shows up strongly in the average-power data as well as in the peak-to-average-power-ratio data (RFI-2) in the central frames. The PA chain turns on at the

end of this transmission. Immediately, there is an increase in the noise level in the command receiver, caused by formation of intermodulation products in the spacecraft between the down-link and primary telemetry signals. The level of this self-interference was stronger than that of the command signals received by the spacecraft, but it did prove possible to get the command "Commands Normal" in during this interval.

At the end of the primary-command-mode interval, the RFI instrument began its scan across a portion of the military UHF band. The average-power channel, confirmed by the peak-to-average-power-ratio channel, shows the successive appearance of these intermodulation product terms (Table 5). For most of this RFI scan (excluding sensitivity-test intervals), the down-link signal consists of the beacon signal (very narrowband) plus a 100-kHz-wide noise signal with spectral tails. The intermodulation products are broadened by the corresponding (N-1) factors. The next primary-command-mode interval (mode 1, partially shown in Fig. 34) has a lower level of intermodulation-product effect in the average power channel. This indicates the intermodulation products had been getting smaller during the 16 minutes since turn-on of the PA chain. The conclusion is strengthened by noting that the center frequency of primary command channel 1 (255.0 MHz) is closer to the center frequency of the (2, 3) intermodulation product (253.85 MHz) than is the center frequency of primary command channel 2 (255.3 MHz).

TABLE 5 INTERMODULATION-PRODUCT FREQUENCIES IN THE RFI-SCAN BAND			
f_{INTERMOD} (MHz)	$N f_{\text{TLM}}$ (N)	$-(N-1) f_{\text{DOWN}}$ (N-1)	Order (2N-1)
279.50	6	5	11th
270.95	5	4	9th
262.40	4	3	7th
253.85	3	2	5th

After the main telemetry transmitter was turned off (not shown in Fig. 34, see Section III-A and Appendix C) these intermodulation products ceased to exist. The full sensitivity of the transponder receiver, measurable directly or by the X5 telemetered test point (Section IV-G) was regained. RFI-scan data became representative of the electromagnetic environment that was under surveillance.*

VII. ECLIPSE EFFECTS

The transponder is entirely dependent on power from the solar-cell array. The LES-5 orbit experiences semiannual seasons of eclipse by the Earth, overlapping the vernal and autumnal equinoxes. (Eclipse of LES-5 by the Moon is possible in principle, but seems unlikely; the matter has not been studied.) The times of eclipse can be predicted accurately. Inclination of the orbital plane with respect to the Earth's equator and the right ascension of its ascending node (Section III-B) introduce asymmetry into the eclipse seasons. They are not generally symmetrical about the equinoxes, nor does the longest eclipse generally occur in immediate proximity to the equinox.

During the 1967 fall season, only a few of the eclipses of LES-5 were actually observed at LL. The observations agreed with calculations, permitting the satellite's eclipse history to be

* See Appendix E for recent data.

summarized from calculations. The spacecraft is eclipsed by Earth about 60 times on some 55 days during each semiannual eclipse period. Considering this number of days in relation to a half-year, 3 out of 10 days have eclipse effects of greater or lesser magnitude. This fraction should not be interpreted as a probability, for the eclipse intervals do not occur in chance fashion.

Adding the time of umbra and penumbra calculated for LES-5 during the fall eclipse period of 1967, LES-5 experienced abnormal operating conditions for a total of approximately 3287 minutes (392 minutes of penumbra, 2895 minutes of umbra). In relation to the number of minutes in a half-year, the fraction of time LES-5 is out of service because of eclipses is 0.0125. In relation to the number of minutes in the 55-day-long eclipse period, the fraction is 0.0415. For the days of longest eclipse (about 70 minutes in each 1316-minute orbital period), the outage fraction is 0.053.

A. Spacecraft Power System

All on-board electrical power, except for a small battery in the 5-year turn-off timer, is supplied by two solar-cell arrays that gird LES-5 above and below the sensor viewband (Figs. 1 and 2). Power from the arrays passes through four output-voltage-regulated DC-to-DC power converters. The regulation is quite effective until the solar-bus voltage drops below a turn-off threshold set within each power converter. The converters operate via a priority system (Table 6).[†]

Power Converter	Rising Bus Voltage	Falling Bus Voltage	Units Powered
1	First on	Last off	Primary telemetry system
2	Second on	Third off	All other equipment
3	Third on	Second off	2 of 4 output PA modules
4	Fourth on	First off	2 of 4 output PA modules

B. Transponder Performance

The transponder's observed performance during and after eclipse agrees with expectations based on the results of pre-launch system testing. Briefly, the two power converters that supply voltage for the four PA modules drop in output as the solar-bus voltage goes down during penumbra entrance. The output power from the PA chain drops accordingly. On emergence from umbra and penumbra the two power converters come back on in reverse sequence. RF power returns to its proper level. Just after emergence from shadow, the solar-bus voltage is higher than normal because the solar-cell arrays are quite cold. This thermal transient lasts one or two hours (depending on the duration of the eclipse).

The thermal transients imposed on the insulated beacon oscillator and two local oscillators are more complex. As the eclipses lengthen, the oscillators do not have time to recover between the end of one and the start of the next. Consequently, as the eclipse cycle nears its end, they run cooler than usual. All transponder elements restabilize thermally within a few days after the last eclipse.

[†] See Appendix D for recent data.

Study of data telemetered during PA chain shutdown and startup indicated two test-point readings correspond to observables different from those they were intended to represent. This effect can be seen in test records from pre-launch telemetry at Cape Kennedy; it was not noticed at the time. It could have been caused by a simple cabling error, but it has no effect on transponder operation.

VIII. OBSERVED PROPAGATION EFFECTS

Fading of signals from LES-5 has been observed occasionally at the Lexington terminal. Fading occurs frequently when the satellite is close to the horizon; sometimes at elevation angles greater than 5°. The received signals are usually extremely steady without measurable variation; yet, variations up to 3 db and even greater have been observed. This fading is not believed to be caused by ground-reflection multipath as the receiving-antenna beamwidth is narrow (about 10°) and the area is surrounded by wooded hills. Of course, small periodic variations are always observed because of satellite spin (Section IV-B2, Fig. 11).

Table 7 contains a summary of fading greater than 3 db observed at elevation angles greater than 5° through August 1967. Character of the fading during the period is indicated by samples of strip-chart recordings (Figs. 35 and 36). The first fading observed after August occurred 12 December 1967 (Fig. 37).

Received-signal-level variations in the LES-5 beacon also have been observed and recorded by the Air Force Cambridge Research Laboratories at the Sagamore Hill Station.⁹

TABLE 7 FADING GREATER THAN 3 DB AT ELEVATION ANGLES GREATER THAN 5° OBSERVED AT THE LEXINGTON TERMINAL							
1967		Start Time (GMT)	Elapsed Time (min.)	Elevation Angle (deg)	Signal Variation (db)	Total Visibility (hr)	Observation Period (hr)
Visible Period	Fade						
July 1-4	July 4	0327	1	13	3-10	67	59.7
		1033	25	7	>10		
		1058	35	7	3-10		
July 10-15	July 14	1420	26	24	3-10	116	47.4
		1446	10	21	>10		
July 21-26	July 24	1510	10	39	3-10	116	23.8
		1530	10	39	3-10		
	July 25	1410	15	18	3-10		
		1445	60	18	3-10		
Aug. 1-6	Aug. 2	0418	87	8	>10	116	63.4
		0545	30	10	3-10		
		1230	10	24	3-10		

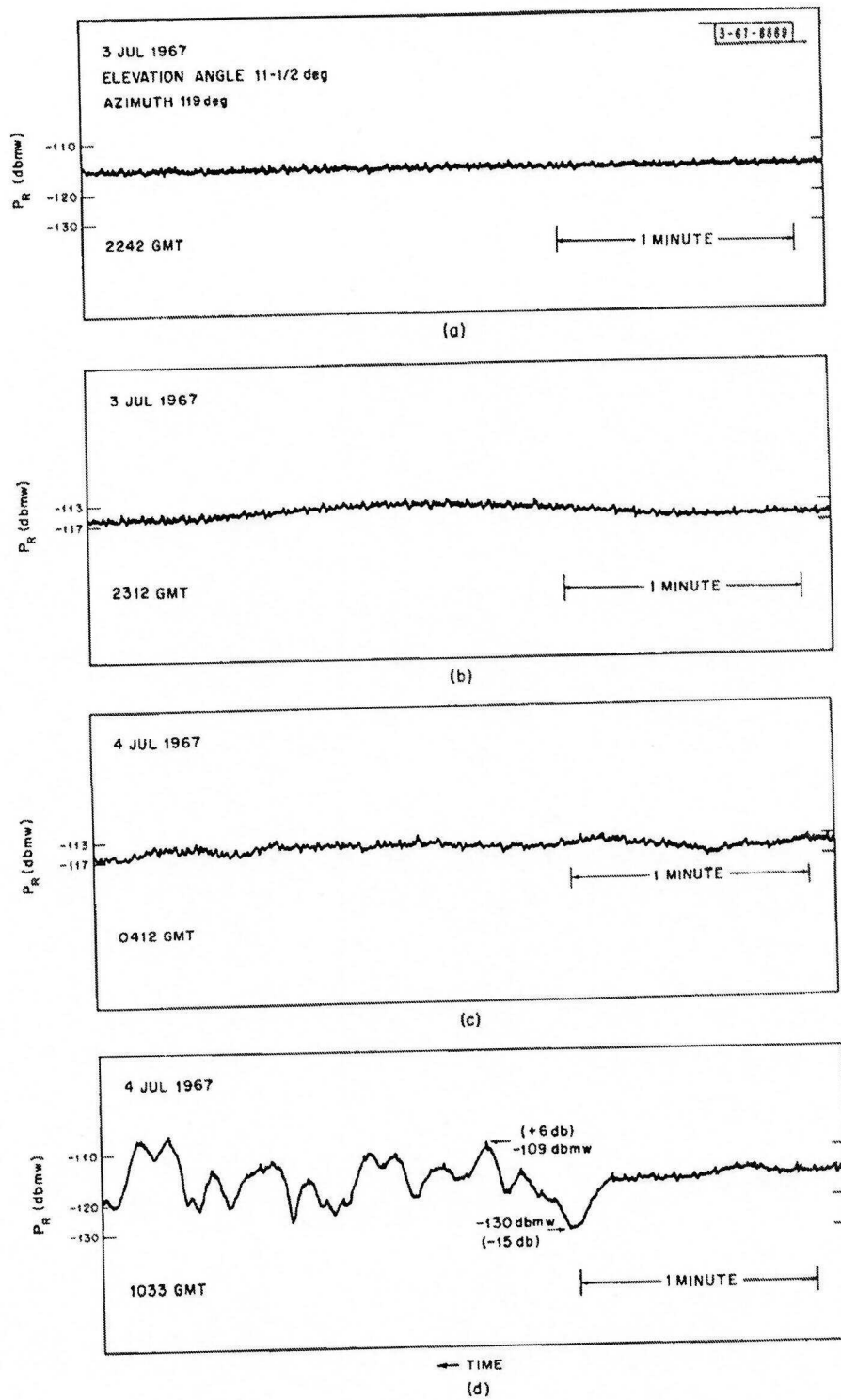

Fig. 35. Example of fading via the beacon: (a) steady signals, (b) slight fading, (c) more jittering fading and (d) severe fading.

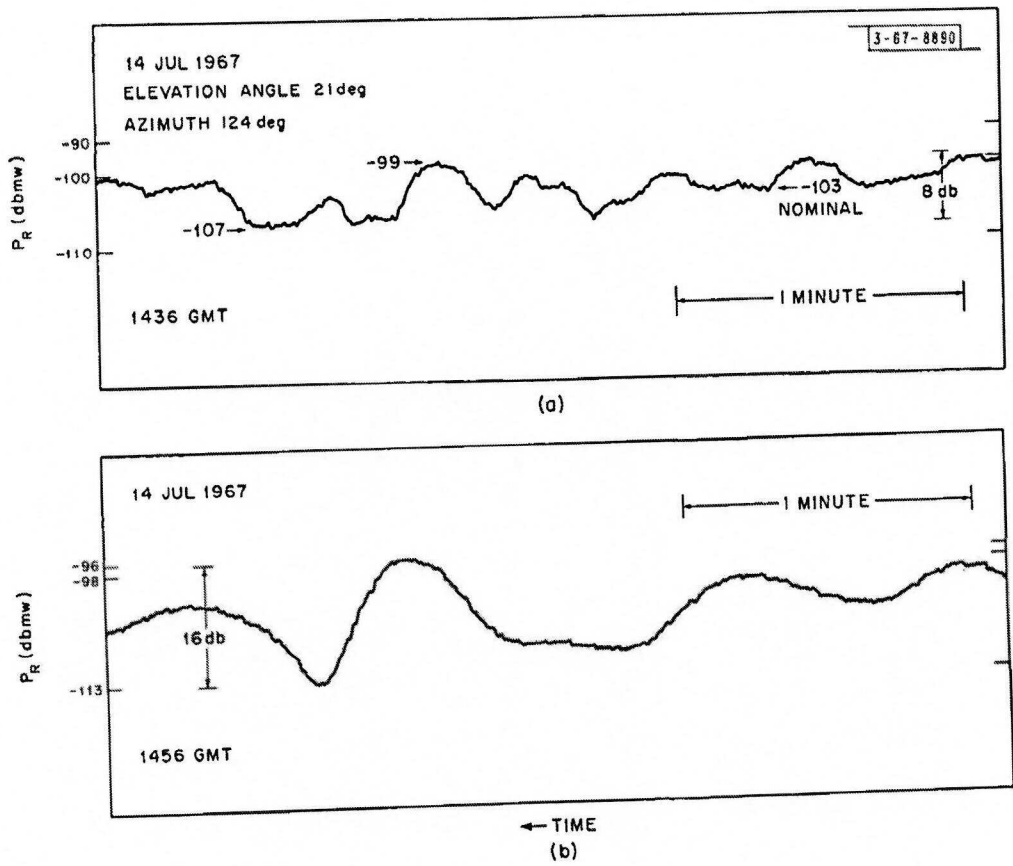
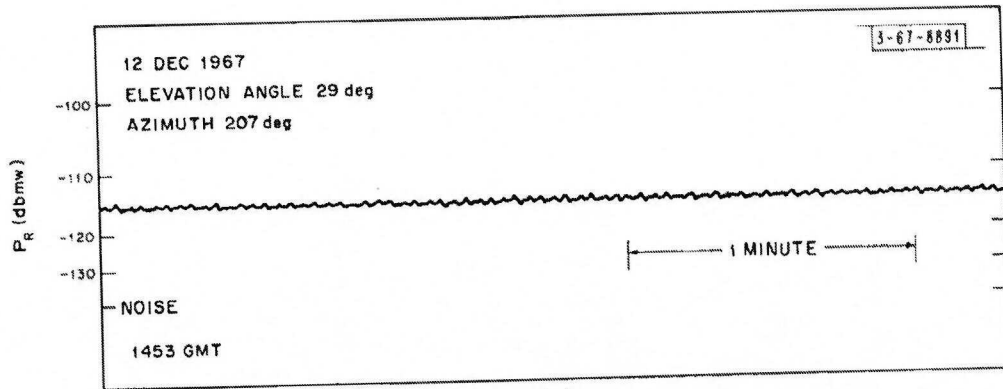
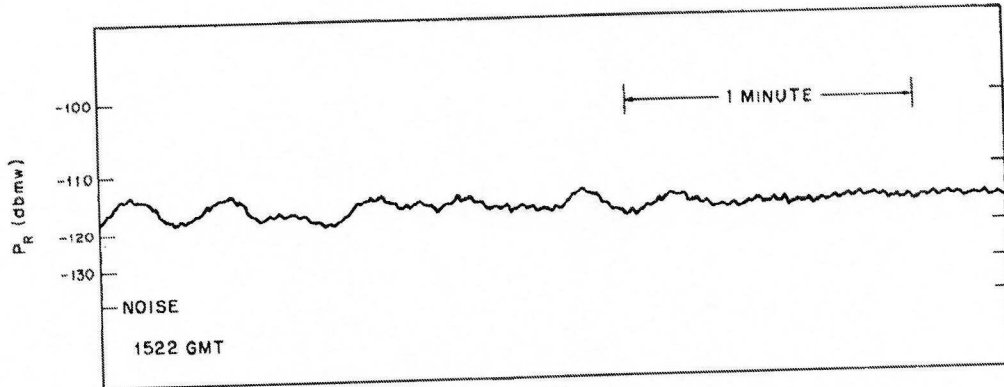

Fig. 36. Examples of fading via the transponder tone.



(a)



(b)

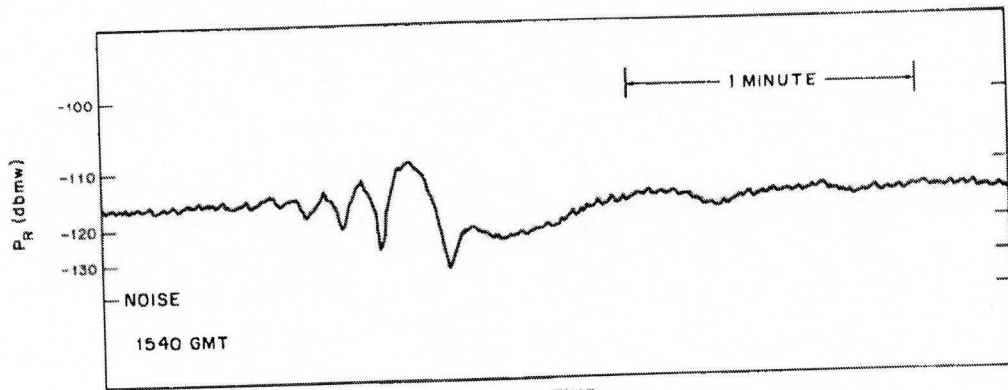

(c)

Fig. 37. Examples of fading via the beacon: (a) steady signals, (b) slight fading and (c) severe fading.

APPENDIX A
MEASUREMENT OF CERTAIN LES-5 OSCILLATOR FREQUENCIES

Certain LES-5 oscillator frequencies can be measured with considerable precision in well equipped ground terminals. For accurate results, the data from these measurements must be corrected for Doppler effects caused by relative motion of the terminal and the satellite. This Appendix presents the correction procedures, with examples.

1. BEACON CARRIER FREQUENCY

The test procedure at the Lexington terminal involves comparing the received beacon signal (nominally having a carrier at 228.43 MHz) with a standard frequency of 62.004 MHz. The difference carrier frequency (nominally 166.426000 MHz) is measured via a phase-locked loop. Often, only the departures from the nominal value are recorded. The beacon carrier frequency has also been measured by the frequency-doubling-and-beat-note-cancellation technique used during transponder testing. The results agree to within the accuracy of the instrumentation, provided a common frequency standard is used.

The measured frequency must be corrected for the (one-way) Doppler effect to find the frequency - as observed aboard the spacecraft - of the beacon carrier. The correction is made only approximately, but adequate for the LES-5 orbital motion and frequencies. The rationale is as follows (t = terminal, s = satellite, o = nominal value):

$$\begin{aligned} (f_{\text{BCN}})_t &= (f_{\text{BCN}})_o + (\Delta f_{\text{BCN}})_t \\ (f_{\text{BCN}})_s &= (f_{\text{BCN}})_o + (\Delta f_{\text{BCN}})_s \\ (f_{\text{BCN}})_t &\approx (f_{\text{BCN}})_s \left[1 - \left(\frac{\dot{R}}{C} \right) \right] \\ (\Delta f_{\text{BCN}})_{\text{Doppler}} &= - \left(\frac{\dot{R}}{C} \right) (f_{\text{BCN}})_o \end{aligned}$$

then

$$(\Delta f_{\text{BCN}})_s \approx (\Delta f_{\text{BCN}})_t - (\Delta f_{\text{BCN}})_{\text{Doppler}}$$

Note that the Doppler-correction term is defined so as to be positive for decreasing range ($\dot{R} < 0$) between the satellite and the terminal. The value of the Doppler-correction term is obtained by interpolation in the Satellite Pass Calculations (LB05 printout). A typical example (taken late in the third Lexington visibility) follows:

Time	25 July 1967, 20:25 GMT
Observed difference frequency	166.425934 MHz
Observed departure from nominal	$(\Delta f_{\text{BCN}})_t = -66 \text{ Hz}$
Calculated Doppler effect (from LB05)	$(\Delta f_{\text{BCN}})_{\text{Doppler}} = -10 \text{ Hz}$
Corrected departure from nominal	$(\Delta f_{\text{BCN}})_s = -56 \text{ Hz}$

The corrected beacon carrier frequency (that which would be measured aboard the satellite) is $(f_{\text{BCN}})_s = 228.429944 \text{ MHz}$.

2. TELEMETRY CARRIER FREQUENCY

The test procedure used in the Westford terminal involves comparing the received telemetry signal (nominally having a carrier at 236.75 MHz) with a standard frequency of 10.050000 MHz. The difference carrier frequency (nominally 226.700000 MHz) is measured via a phase-locked loop based on a quadrupled oscillator nominally at 56.675000 MHz. Often, only the departures from this latter frequency are recorded.

The results must be corrected for the (one-way) Doppler effect to find the frequency - as observed aboard the spacecraft - of the telemetry carrier. The correction is made only approximately, but adequate for the LES-5 orbital motion and frequencies. The rationale is the same as for the beacon carrier frequency. The LB05 prediction for the Doppler correction must be scaled. The Doppler term in the printout is positive for decreasing range between the spacecraft and the terminal.

The only successful measurements of telemetry carrier frequency for the first 7 hours in orbit were made at the Westford terminal. For example:

Time	1 July 1967, 21:10 GMT
Observed telemetry carrier frequency	236.750176 MHz
Calculated Doppler correction at the beacon frequency	-14 Hz*
Scaled Doppler correction at the telemetry frequency	-15 Hz
Corrected telemetry carrier frequency	236.750191 MHz.

3. FREQUENCY TRANSLATION AFFORDED BY THE TRANSPONDER

Monostatic measurements of the frequency translation afforded by the LES-5 transponder have been made at the Lexington terminal. The results of such measurements can be corrected to give the difference frequency between the two local oscillators in the transponder. The procedure is:

- (a) A strong CW up-link signal lying within the transponder's acceptance band is transmitted. Its nominal (or center frequency) value is 255.1 MHz. The exact frequency of this up-link signal is not critical, but it must be measured precisely (generally by direct counting). Often, only the departures from the nominal value are recorded.
- (b) The frequency of the corresponding down-link signal is then measured. In practice, this received CW signal (nominally at 228.2 MHz) is compared with a standard frequency signal at 62.004 MHz. The difference frequency carrier (nominally at 166.196000 MHz) is measured via a phase-locked loop. Often, only the departures from the nominal value are recorded.
- (c) The data from (a) and (b) must be corrected for the two-way Doppler effect to find the transponder's frequency translation observed aboard the spacecraft.

The Doppler-effect correction (c) is only approximate, but adequate for the LES-5 orbital motion and frequencies. The following general relations are derived on the premise that the frequency translation of the transponder is positive when the down-link frequency lies below the up-link frequency (as for LES-5). The sign of the departure from the nominal frequency translation (26.9 MHz) is consistent with this convention.

* Assumed the same for the Westford and Lexington terminals.

At the terminal (subscript t):

$$(f_{\text{up}})_t = (f_{\text{up}})_o + (\Delta f_{\text{up}})_t$$

Going into the spacecraft (subscript s):

$$(f_{\text{up}})_s \approx (f_{\text{up}})_t + (\Delta f_{\text{up}})_{\text{Doppler}}$$

Within the spacecraft:

$$(f_{\text{trans}})_s = (f_{\text{trans}})_o + (\Delta f_{\text{trans}})_s$$

Coming out of the spacecraft:

$$(f_{\text{down}})_s = (f_{\text{up}})_s - (f_{\text{trans}})_s$$

At the terminal again:

$$\begin{aligned}(f_{\text{down}})_t &= (f_{\text{down}})_o + (\Delta f_{\text{down}})_t \\ &\approx (f_{\text{down}})_s + (\Delta f_{\text{down}})_{\text{Doppler}}\end{aligned}$$

Substituting and simplifying:

$$\begin{aligned}(f_{\text{down}})_o + (\Delta f_{\text{down}})_t &\approx (\Delta f_{\text{down}})_{\text{Doppler}} + (f_{\text{up}})_o + (\Delta f_{\text{up}})_t \\ &\quad + (\Delta f_{\text{up}})_{\text{Doppler}} - (f_{\text{trans}})_o - (\Delta f_{\text{trans}})_s\end{aligned}$$

By definition, the nominal values satisfy:

$$(f_{\text{down}})_o = (f_{\text{up}})_o - (f_{\text{trans}})_o$$

Eliminating and solving:

$$(\Delta f_{\text{trans}})_s \approx (\Delta f_{\text{up}})_t - (\Delta f_{\text{down}})_t + (\Delta f_{\text{down}})_{\text{Doppler}} + (\Delta f_{\text{up}})_{\text{Doppler}}$$

The Doppler corrections are obtained by interpolation and scaling in the Satellite Pass Calculations (LB05 printout). The Doppler term in the printout is positive for decreasing range between the spacecraft and the terminal, and it has been calculated for the beacon frequency (228.43 MHz). A typical example (taken late in the third Lexington visibility period) is worked out.

Time: 25 July 1967, 12:25 GMT

$$\text{Observed } (\Delta f_{\text{up}})_t = -725 \text{ Hz } [(f_{\text{up}})_t = 255.099275 \text{ MHz}]$$

$$\text{Observed } (\Delta f_{\text{down}})_t = -653 \text{ Hz } [(f_{\text{down}})_t = 62.004000 + 166.195347 \text{ MHz}]$$

$$\text{Calculated } (\Delta f_{\text{BCN}})_{\text{Doppler}} = -38 \text{ Hz (from LB05)}$$

$$\text{Scaled } (\Delta f_{\text{up}})_{\text{Doppler}} = \left(\frac{255.1}{228.43} \right) (-38) = -42 \text{ Hz}$$

$$\text{Scaled } (\Delta f_{\text{down}})_{\text{Doppler}} = \left(\frac{228.2}{228.43} \right) (-38) = -38 \text{ Hz}$$

$$\text{Corrected } (\Delta f_{\text{trans}})_s = -725 - (-653) - 38 - 42 = -152 \text{ Hz}$$

That is, the translation frequency that would be measured aboard the spacecraft is

$$(f_{\text{trans}})_s = 26.899848 \text{ MHz}$$

APPENDIX B
CIRCUIT FAILURE IN RF AMPLIFIER 1

There was a circuit failure in RF amplifier 1 on 18 March 1968. This failure was associated with the eclipse of LES-5 by the Earth between approximately 0925 and 1015 GMT. The immediate consequence of this failure was a ~17-db degradation in transponder sensitivity. There was an equal degradation in the threshold sensitivity of the RFI instrument, which receives its input signals from RF amplifier 1 (Fig. 4).

Measurement of LES-5 transponder-receiver sensitivity in orbit is discussed in detail in Section IV-G. Results of tests made after the circuit failure by the over-all method and by the X5 method agree. A typical X5 measurement made in the narrowband mode on 22 March 1968 at 1800 GMT from Lexington was:

Up-link transmitter power for 3-db-down threshold	+ 43.0 dbmw (20 w)
Up-link RHCP antenna gain (estimated)	+ 24.0 db
-----	-----
Up-link RHCP EIRP for 3-db-down threshold	+ 67.0 dbmw
(Path loss, 38,500 km) ⁻¹	- 172.2 db
LES-5 antenna gain	+ 1.6 db
-----	-----
Up-link power at the triplexer antenna port (P _r)	- 103.6 dbmw
P _r before the failure (Section IV-G)	- 120.1 dbmw
-----	-----
Degradation in sensitivity	~ 17 db

The degradation factor determined from this single-frequency measurement can be applied to across-the-band performance figures if it is assumed (as seems reasonable) that the effects of the circuit failure are broadband in comparison with the up-link bands passed by the IF crystal filters. On this basis, the best across-the-band estimates of transponder sensitivities currently available are:

<u>Bandwidth</u>	<u>Before Failure</u>	<u>After Failure</u>
Narrow	- 120 dbmw	- 103 dbmw
Wide	- 115 dbmw	- 98 dbmw

Figure 38 shows transponder-saturation curves measured after the failure, along with some before-the-failure data (compare Figs. 19 and 22).

By a remarkable coincidence, a USAF tracking station on Guam was recording telemetered data from LES-5 during the time interval before and after this eclipse. Comparison of pre- and post-eclipse data shows very slight changes (< 2 percent) in the indicated current drains of three active units in the transponder receiver. RF amplifier 1, on the other hand, shows a decrease of about 4 ma from 36 ma.

Analysis of the circuit failure was conducted with the aid of a back-up RF amplifier essentially identical with that flown. It was found that a current decrease of this magnitude was consistent with an open circuit somewhere in the components and connections associated with the emitter junction of the input transistor (a germanium device). The results of these bench tests

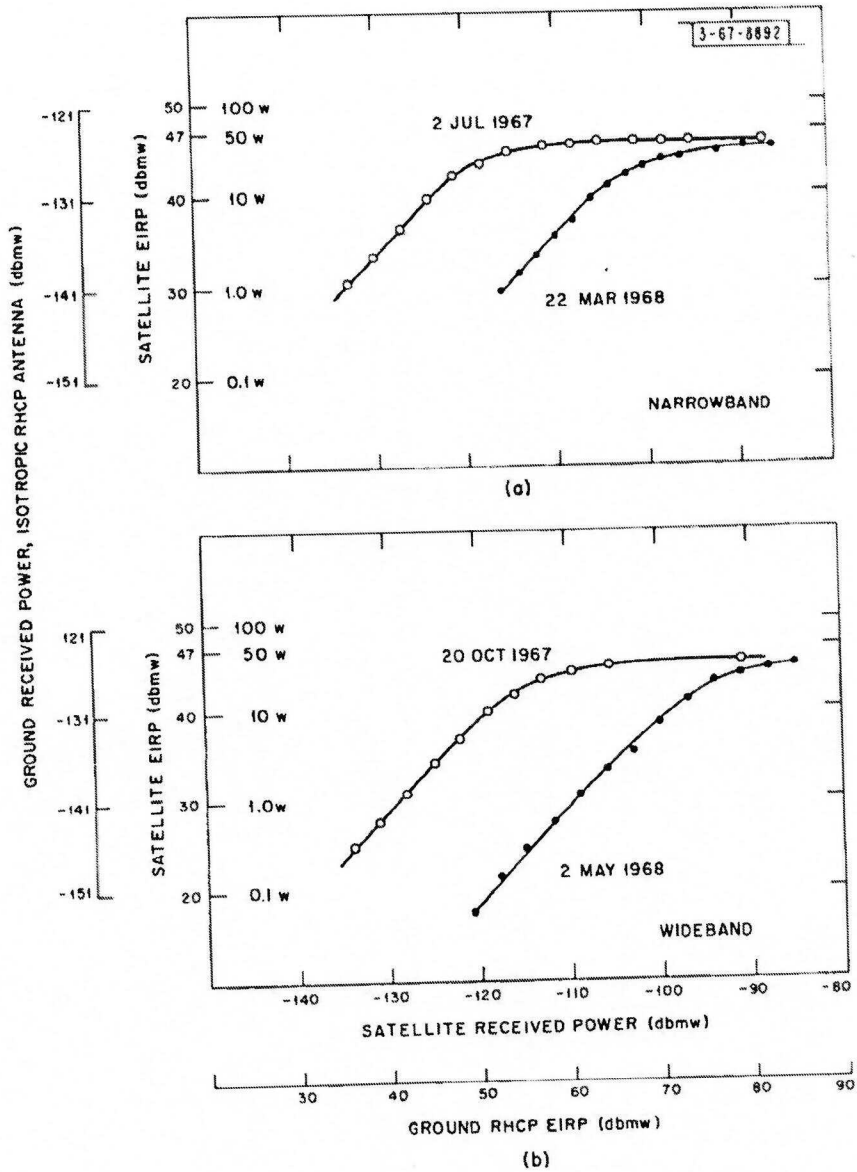

Fig. 38. Transfer curves: (a) narrowband, (b) wideband.

are in good agreement with the measured degradation in transponder sensitivity (about 17 db) and the measured reduction in strong-signal RF gain at 255 MHz (about 21 db, as observed through the RFI instrument).

Several transistors of that same sort have been dissected and examined. Their operating characteristics have been considered in relation to the circuit requirements. High-voltage (DC and RF) tests have been made. It is by no means obvious that the transistor is at fault. Considering the evident high quality of its design and manufacture, the likelihood is greater that the open circuit occurred somewhere in circuit components or connections external to the transistor. If such is the case, there is a remote possibility that more thermal cycling (such as is experienced in passing through long eclipses) will restore the intermittent connection and undo the damage. The likelihood is small, however.*

The equivalent system noise temperature of 660°K calculated in Section IV-C has now become $33,000^{\circ}\text{K}$, with corresponding 17-db increases in the noise-power density, the noise power in a given bandwidth, etc. It is interesting to interpret this rise in transponder self-noise in terms of equivalent noise-like interfering signals, such as would be present if the transponder were already in multiple-access use. An estimate of this equivalence can be made from some numbers in Section IV-G. In connection with the peak-sensitivity measurements, at $\sim 36,000\text{-km}$ range, an up-link RHCP EIRP of $+47.5\text{ dbmw}$ was required to reach the 3-db-down narrowband threshold of -121.9 dbmw at the triplexer antenna port. The 17-db increase in noise figure implies an equivalent up-link RHCP EIRP of $(47.5 + 17) = +64.5\text{ dbmw}$, about 3 kw. Use of the degraded LES-5 transponder in the narrowband mode now is equivalent to using the undegraded transponder in the presence of that much simultaneous usage. In relation to the wideband mode, the corresponding equivalent up-link RHCP EIRP is about 10 kw.

* Note added during proofreading: The transponder suddenly regained its original sensitivity while being used for tests on 14 November 1968. The Fall series of eclipses had ended on 23 October 1968.

APPENDIX C
COMMAND USAGE

Substantive commands sent to LES-5 thus far (Table 8) were all successful. Dummy commands 29 and 30, which have been sent on several occasions for test purposes, are not included.

TABLE 8 COMMANDS SENT TO LES-5			
Date	Transmission Start Time (GMT)	Command	Mode
2 July 1967	02:49:04	8 - Transponder ON	Primary 2
2 July 1967	02:50:00	31 - Commands Normal	Primary 2
2 July 1967	03:19:40	1 - Telemetry OFF	Alternate
2 August 1967	14:01:08	4 - Mag Stab ON	Alternate
20 October 1967	02:00:35	10 - Transponder Wide IF	Primary 1
20 March 1968	04:10:30	9 - Transponder Narrow IF	Alternate
23 April 1968	23:12:00	10 - Transponder Wide IF	Alternate
15 May 1968	23:14:00	9 - Transponder Narrow IF	Alternate
31 August 1968	04:57:40	2 - Telemetry ON	Alternate
31 August 1968	06:12:30	1 - Telemetry OFF	Primary 2
12 September 1968	23:30:30	2 - Telemetry ON	Primary 2
12 September 1968	23:52:40	1 - Telemetry OFF	
13 September 1968	21:09:25	2 - Telemetry ON	Primary 1

APPENDIX D
POWER-SYSTEM DEGRADATION

Telemetry data from LES-5 in mid-May 1968 indicated the solar-bus voltage was falling at a faster-than-anticipated rate. Further, there was a marked change in the power-system performance between May 10 and 13 (the available segments of telemetered data). Study of the data shows there has been a failure in some series-connected cell group on one of the solar-cell-array panels.

The basic sampling interval for LES-5 telemetry is 10.24 sec. The spin period of the satellite is about 5.3 sec. It is possible, however, to work from time correlations to de-alias the telemetered data under the assumption that spin-periodic phenomena are involved.

Figure 39 shows the output voltage of power converter No. 4. For the 180° of satellite rotation in which the failed-connection group of cells is in shadow, the solar-bus voltage is at its full level (degraded slightly from what was expected, however). As the failed-connection group

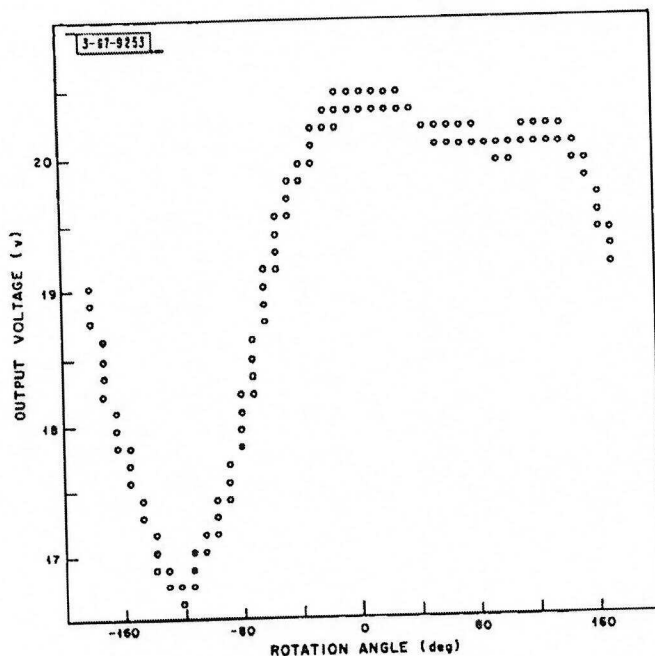

Fig. 39. Output voltage from power converter No. 4 as a function of LES-5 rotation. Data taken 17 July 1968.

of cells comes into sunlight, the solar-bus power decreases, the solar-bus voltage drops, and the power converter goes further out of regulation – its output voltage falls sharply. The solar-bus voltage recovers as the failed-connection group of cells passes out of sunlight.

There are 48 series-connected cell groups on LES-5 (3 per panel, 8 panels above and 8 panels below the viewband, Figs. 1 and 2). Assuming nominal spin-axis orientation, 24 cell groups are sunlit at any given time. The maximum short-circuit current contributed by each group of cells at the time of the measurement in space* was approximately 230 ma. From Fig. 39 and PA-chain

* Data corrected for sun declination, temperature, and estimated cell degradation.

data, 240 ma was estimated as the drop in equivalent short-circuit current at the valley of the curve, strong evidence that one of the 48 cell groups has been taken out of action by circuit failure. Further study of data taken during the first 10 months in orbit might disclose signs of incipient failure.

In addition to this rather definite failure, there remains the question of the faster-than-expected degradation of unaffected solar cells. The power-converter output voltage for the "good" side of LES-5 is about 20 v instead of 26 v. This degradation has been investigated at the Laboratory using information from outside sources (LES-5 is not the only satellite so affected) and data from the LES-5 solar-cell-calibration experiment. Tentative results are presented in Table 9; these factors are more than enough to account for the observed degradation.

TABLE 9 LES-5 POWER-SYSTEM DEGRADATION AFTER ONE YEAR IN ORBIT	
Degradation Source	Percent Degradation
Solar-Cell Array (Power Loss)	
Low-energy-proton edge effect	~15*
Solar-cell-connection failure (May 10-13, 1968)	13 max
UV degradation of coverslides and adhesives	> 4
Conventional radiation effects from trapped electrons	< 4
Contamination and contact	< 5
Solar-Cell-Calibration Experiment (Short-Circuit-Current Loss)	
UV degradation of coverslides and adhesives	> 4
Conventional radiation effects from trapped electrons	< 4
Contamination	< 5
Total solar-cell degradation	~12
* Found by Hughes Aircraft Co. with ATS-I and Intelsat II.	

Construction and mode of operation of the solar-cell array and the solar-cell-calibration experiment are different. The coverslides were cemented with one preparation in the array and with another in the experiment. Therefore, UV and contact degradations will differ. Also, the low-energy-proton edge effect does not affect the short-circuit current.

The solar-cell-connection failure and low-energy-proton edge effects are the most serious degrading effects in the array. The 15 percent degradation (Table 9) is from the experience of Hughes Aircraft Co. with ATS-I and Intelsat II. A good estimate of the low-energy-proton edge effect in LES-5 is impossible because precise measurements on the exposed areas of the solar panels were not obtained before launch.

The effect of more obscure sources such as contamination due to surface creep of silicones, contact degradation, and darkening of the magnesium fluoride anti-reflection coating by low-energy protons, appears to be minor. Conventional radiation effects caused by charged particles penetrating into the solar cells are less than four percent.

In May 1968, the telemetered output of the LES-5 PA chain showed a fractional-db drop in output power that agreed, in general, with EIRP calculations based on measurement of the down-link power received at the Lexington terminal. At that time, the degradation in solar-cell output, together with the cell-group failure, were sufficient to cause one of the two DC-to-DC power converters feeding the four PA-chain final modules to drop far out of regulation during a portion of each satellite spin period.

As the degradation effects continue, a point will be reached when power converter No. 4 turns off altogether, leaving two of the four PA-chain final modules without power. The hybrid power-summing arrangement at their output will then introduce a further 3-db drop in output power from the transponder transmitter. There will thus be a 6-db drop in down-link and beacon EIRP's. LES-5 will continue to operate in that mode for a long time, until solar-cell degradation progresses to the point that the other DC-to-DC power converter (No. 3) feeding the PA-chain final modules also drops far out of regulation during a portion of each satellite spin period and ultimately turns off. At that time, the usefulness of LES-5 as a communications repeater will be effectively over. Data from the other on-board experiments can still be received via the primary telemetry transmitter, however.

APPENDIX E
REACTIVATION OF LES-5 TELEMETRY TRANSMITTER

In late August, 1968, it was decided to reactivate the LES-5 telemetry transmitter. There was considerable curiosity regarding the level of intermodulation products formed between the telemetry and transponder transmitters after a year in space (Section VI-B). It was also thought prudent to have the primary channel for spacecraft telemetry and timing signals available. Further degradation in the solar-cell array output might cause unexpected shutdown of the PA chain, and consequent loss of the beacon signal carrying the telemetry modulation (Section V, Appendix D).

The telemetry transmitter was turned ON and OFF for two brief data-taking intervals on August 31 and September 12. On September 13 it was turned ON and left in that condition (Appendix C). The telemetry transmitter turned ON without incident on these three occasions. The telemetry signal was acquired and data recorded at the Westford and Camp Parks tracking stations. Received signal levels were consistent with pre-launch measurements (Section IV-B). The carrier frequency measured at Westford August 31 was 236.750036 MHz after Doppler-effect correction (Appendix A).

There is no indication that degradation of the solar-cell array will bring about permanent shutdown of the LES-5 PA chain within the immediate future. Regarding intermodulation products, the fifth-order (2, 3) term had decreased by at least 26 db over that observed on launch night (Fig. 34), the only previous occasion when both transmitters were turned ON in orbit. This measurement would have been more informative had it not been for the 17-db sensitivity degradation caused by failure in RF amplifier No. 1 (Appendix B). The fifth-order (and higher) intermodulation products may be down by much more than this amount. Perhaps some beneficent effect of the space environment (cold-welding of finger-stock electrical contacts, for example) is responsible for this blessing.

APPENDIX F
GLOSSARY OF ACRONYMS AND ABBREVIATIONS

AT	Crystallographer's description of a particular way of cutting a crystal relative to its lattice structure.
BW	Bandwidth
BCN	Beacon
BPF	Bandpass filter
dbm, dbmw	db with respect to one-milliwatt power level
DC	Direct current
ECI	Electronic Communications, Inc.
EIRP	Effective isotropic radiated power
f_o	Center frequency of a frequency-selective component
Hz	Hertz, 1 cycle per second
IEEE	Institute of Electrical and Electronics Engineers
IF	Intermediate frequency
k	Boltzmann's constant
kHz	Kilohertz, 10^3 cycles per second
LES	Lincoln Experimental Satellite
LET	Lincoln Experimental Terminal
LHCP	Left-hand circular polarization
LL	Lincoln Laboratory
LO	Local oscillator
MHz	Megahertz, 10^6 cycles per second
mw	Milliwatt
PA	Power amplifier
RCA	Radio Corporation of America
REC	Receiver
RF	Radio frequency
RFI	Radio-frequency interference
RHCP	Right-hand circular polarization
rpm	revolutions per minute
TLM	Telemetry
T_o	Reference temperature
bps	Bits per second

ACKNOWLEDGMENTS

It would be a formidable task to list all the organizations and people who have contributed to the development, fabrication, and testing of LES-5, before and after launch. Rather than slight anyone, the many individuals and their contributions are not listed. The extensive participation of firms and laboratories operating in close coordination with Lincoln Laboratory in this program are more readily recognizable. That participation is gratefully acknowledged. The major entities concerned with the transponder were:

Electro Optical Systems	Solar-cell arrays
Engineered Magnetics Division, Gulton Industries	DC-to-DC power converters
Western Microwave Laboratories, Inc.	Transponder receiver
Radio Corporation of America Laboratories Division, Aerospace Corporation	Transponder PA chain RFI instrument
McCoy Electronics Co.	Crystal IF bandpass filters
CTS Knights	Beacon and telemetry oscillators

REFERENCES

1. R. R. Allan and G. E. Cook, "The Long-Period Motion of the Plane of a Distant Circular Orbit," *Proc. Roy. Soc. (London)* 280, 97 - 109 (1964).
2. A. Sotiropoulos, "LES-5 Triplexer," Technical Report 438, Lincoln Laboratory, M.I.T. (31 August 1967), DDC 823174.
3. L. V. Blake, "Antenna and Receiving-System Noise-Temperature Calculation," Naval Research Laboratory Report 5668, 1 - 7 (19 September 1961).
4. W. B. Davenport, Jr., "Signal-to-Noise Ratios in Band-Pass Limiters," *J. Appl. Phys.* 24, 6, 720 - 727 (June 1953). See also Technical Report 234, Research Laboratory of Electronics, M.I.T. (29 May 1952).
5. J. C. Springett, "A Note on Signal-to-Noise and Signal-to-Noise Spectral-Density Ratios at the Output of a Filter-Limiter Combination," *Space Programs Summary* 37-36, Jet Propulsion Laboratory, C.I.T. IV, 241 - 244 (31 December 1965).
6. R. Price, "A Note on the Envelope and Phase-Modulated Components of Narrowband Gaussian Noise," *IRE Trans. Inform. Theory* IT-1, 9, 9 - 13 (September 1955). See also Technical Report 75, Lincoln Laboratory, M.I.T. (26 January 1955), DDC 64030.
7. D. M. Snider, "A Theoretical Analysis and Experimental Confirmation of the Optimally Loaded and Overdriven RF Power Amplifier," Technical Report 428, Lincoln Laboratory, M.I.T. (7 November 1966), DDC 647799. See also *IEEE Trans. Electron Devices* ED-14, 12, 851 - 857 (December 1967); and *NEREM Convention Record*, 20 - 21 (1967).
8. W. W. Ward, K. H. Hurlbut and C. J. Zamites, Jr., "The LES-5 RFI Experiment," joint Aerospace Corporation-Lincoln Laboratory report (to be published).
9. R. S. Allen and H. A. Strick, "Scintillation of the LES-5 Beacon Observed at Sagamore Hill," Air Force Cambridge Research Laboratories (January 1968).
10. M. E. Devane, D. J. Frediani, B. F. LaPage, M. I. Rosenthal and A. Sotiropoulos, "Antenna System for LES-5," Technical Report 451, Lincoln Laboratory, M.I.T. (18 July 1968).
11. N. M. Blachman, "The Output Signal-to-Noise Ratio of a Bandpass Limiter," *IEEE Trans. Aerospace and Electronic Systems*, AES-4, 4, 635 (July 1968).

DOCUMENT CONTROL DATA - R&D		
<small>(Security classification of title, body of abstract and indexing annotation must be entered when the overall report is classified)</small>		
1. ORIGINATING ACTIVITY (Corporate author) Lincoln Laboratory, M. I. T.		2a. REPORT SECURITY CLASSIFICATION Unclassified
		2b. GROUP None
3. REPORT TITLE Lincoln Experimental Satellite-5 (LES-5) Transponder Performance in Orbit		
4. DESCRIPTIVE NOTES (Type of report and inclusive dates) Technical Note		
5. AUTHOR(S) (Last name, first name, initial) Nichols, B. E. Ward, W. W.		
6. REPORT DATE 1 November 1968	7a. TOTAL NO. OF PAGES 68	7b. NO. OF REFS 11
8a. CONTRACT OR GRANT NO. AF 19 (628)-5167	9a. ORIGINATOR'S REPORT NUMBER(S) Technical Note 1968-18	
b. PROJECT NO. 649L	9b. OTHER REPORT NO(S) (Any other numbers that may be assigned this report) ESD-TR-68-60	
c.		
d.		
10. AVAILABILITY/LIMITATION NOTICES This document has been approved for public release and sale; its distribution is unlimited.		
11. SUPPLEMENTARY NOTES None	12. SPONSORING MILITARY ACTIVITY Air Force Systems Command, USAF	
13. ABSTRACT A review and analysis of the first in-orbit year of transponder operation aboard the fifth experimental satellite built by Lincoln Laboratory and launched 1 July 1967. The measured performance of the satellite's UHF transponder as a communications repeater is discussed as are its beacon and telemetry systems.		
14. KEY WORDS		
LES-5 communications transponder LES-6 eclipse effects TATS beacon code	communications satellite telemetry transmitter military UHF band tactical satellite communication LET-4	hard limiter intermodulation products magnetic stabilization FSK modulation crystal IF bandpass filter

UNCLASSIFIED

AD NUMBER

AD857274

LIMITATION CHANGES

TO:

Approved for public release; distribution is unlimited.

FROM:

Distribution authorized to U.S. Gov't. agencies only; Test and Evaluation; 21 JUL 1969. Other requests shall be referred to Space and Missile Systems Organization, Attn: SMR, Los Angeles, CA 90045.

AUTHORITY

SAMSO ltr dtd 14 Nov 1979

THIS PAGE IS UNCLASSIFIED

THIS REPORT HAS BEEN DELIMITED
AND CLEARED FOR PUBLIC RELEASE
UNDER DOD DIRECTIVE 5200.20 AND
NO RESTRICTIONS ARE IMPOSED UPON
ITS USE AND DISCLOSURE.

DISTRIBUTION STATEMENT A

APPROVED FOR PUBLIC RELEASE;
DISTRIBUTION UNLIMITED.